

An Overview on Fault Diagnosis, Prognosis and Resilient Control for Wind Turbine Systems

Authors:

Zhiwei Gao, Xiaoxu Liu

Date Submitted: 2022-11-28

Keywords: wind turbine, energy conversion systems, condition monitoring, fault diagnosis, fault prognosis, resilient control

Abstract:

Wind energy is contributing to more and more portions in the world energy market. However, one deterrent to even greater investment in wind energy is the considerable failure rate of turbines. In particular, large wind turbines are expensive, with less tolerance for system performance degradations, unscheduled system shut downs, and even system damages caused by various malfunctions or faults occurring in system components such as rotor blades, hydraulic systems, generator, electronic control units, electric systems, sensors, and so forth. As a result, there is a high demand to improve the operation reliability, availability, and productivity of wind turbine systems. It is thus paramount to detect and identify any kinds of abnormalities as early as possible, predict potential faults and the remaining useful life of the components, and implement resilient control and management for minimizing performance degradation and economic cost, and avoiding dangerous situations. During the last 20 years, interesting and intensive research results were reported on fault diagnosis, prognosis, and resilient control techniques for wind turbine systems. This paper aims to provide a state-of-the-art overview on the existing fault diagnosis, prognosis, and resilient control methods and techniques for wind turbine systems, with particular attention on the results reported during the last decade. Finally, an overlook on the future development of the fault diagnosis, prognosis, and resilient control techniques for wind turbine systems is presented.

Record Type: Published Article

Submitted To: LAPSE (Living Archive for Process Systems Engineering)

Citation (overall record, always the latest version):

LAPSE:2022.0152

Citation (this specific file, latest version):

LAPSE:2022.0152-1

Citation (this specific file, this version):

LAPSE:2022.0152-1v1

DOI of Published Version: <https://doi.org/10.3390/pr9020300>

License: Creative Commons Attribution 4.0 International (CC BY 4.0)

Review

An Overview on Fault Diagnosis, Prognosis and Resilient Control for Wind Turbine Systems

Zhiwei Gao ^{1,*}  and Xiaoxu Liu ²

¹ Faculty of Engineering and Environment, University of Northumbria at Newcastle, Newcastle upon Tyne NE1 8ST, UK

² Sino-German College of Intelligent Manufacturing, Shenzhen Technology University, Shenzhen 518118, China; liuxiaoxu@sztu.edu.cn

* Correspondence: zhiwei.gao@northumbria.ac.uk

Abstract: Wind energy is contributing to more and more portions in the world energy market. However, one deterrent to even greater investment in wind energy is the considerable failure rate of turbines. In particular, large wind turbines are expensive, with less tolerance for system performance degradations, unscheduled system shut downs, and even system damages caused by various malfunctions or faults occurring in system components such as rotor blades, hydraulic systems, generator, electronic control units, electric systems, sensors, and so forth. As a result, there is a high demand to improve the operation reliability, availability, and productivity of wind turbine systems. It is thus paramount to detect and identify any kinds of abnormalities as early as possible, predict potential faults and the remaining useful life of the components, and implement resilient control and management for minimizing performance degradation and economic cost, and avoiding dangerous situations. During the last 20 years, interesting and intensive research results were reported on fault diagnosis, prognosis, and resilient control techniques for wind turbine systems. This paper aims to provide a state-of-the-art overview on the existing fault diagnosis, prognosis, and resilient control methods and techniques for wind turbine systems, with particular attention on the results reported during the last decade. Finally, an overlook on the future development of the fault diagnosis, prognosis, and resilient control techniques for wind turbine systems is presented.

Keywords: wind turbine; energy conversion systems; condition monitoring; fault diagnosis; fault prognosis; resilient control



Citation: Gao, Z.; Liu, X. An Overview on Fault Diagnosis, Prognosis and Resilient Control for Wind Turbine Systems. *Processes* **2021**, *9*, 300. <https://doi.org/10.3390/pr9020300>

Academic Editor: Krzysztof Rogowski
Received: 31 December 2020
Accepted: 2 February 2021
Published: 5 February 2021

Publisher's Note: MDPI stays neutral with regard to jurisdictional claims in published maps and institutional affiliations.



Copyright: © 2021 by the authors. Licensee MDPI, Basel, Switzerland. This article is an open access article distributed under the terms and conditions of the Creative Commons Attribution (CC BY) license (<https://creativecommons.org/licenses/by/4.0/>).

1. Introduction

In order to enhance the capability of harvesting wind energy, wind turbines have become larger, but more complex and expensive. It would cost 3.3 million pounds per megawatt for installing offshore wind turbines, and spend 1.25 million pounds per megawatt for installing on-shore wind turbines. Working under harsh environments and varying load conditions, wind turbine systems are unavoidably subjected to a variety of anomalies and faults. As is known, the operation and maintenance cost for a wind turbine is relatively high, especially for one built offshore. The operation and maintenance costs for onshore and offshore wind turbines, respectively, make up 10–15% and 20–35% of the total life costs in wind turbine systems [1,2]. Therefore, there is a high demand in wind energy industries to improve the reliability, safety, availability, and productiveness of the wind turbine systems. One of the important techniques is condition monitoring and fault diagnosis, which is to monitor whether a system is healthy, detect any faults or malfunctions in their early stages, determine where the faults occur, and assess the severity of the faults so that appropriate actions can be taken in order to avoid further damages and even dangerous situations in wind turbine systems. Prognosis is a technique to predict potential faults, and estimate the remaining useful life of wind turbine systems so that timely predictive maintenances and repairing can be scheduled. Resilient control is a technique to minimize

the effects from the faulty components or unexpected disruptions so that the wind turbine system can work with tolerant performance degradation under some abnormal conditions. During the past two decades, essential studies were carried out in the area of monitoring, fault diagnosis, prognosis, and resilient control for wind energy systems, which were well documented in the survey papers [3–22]. Table 1 presents some existing survey papers categorized by years and topics. Specifically, non-destructive testing methods of wind turbines at manufacture and in-service were reviewed in [3], aiming to inspect potential flaws in wind turbines. In [4], a brief review was provided for condition monitoring and fault diagnosis for various subsystems and components, such as doubly-fed induction generators, blades, and driven trains. Condition and performance monitoring techniques were surveyed in [5], with focus on blades, rotors, generators, and braking systems. In [6], a variety of condition monitoring and fault diagnosis algorithms for wind turbine systems were overviewed. [7] provided a brief discussion of advantages and limitations of different monitoring and diagnosis methods specified in each subsystem. In [8], the review focused on condition monitoring and diagnosis for wind turbine components using signal processing methods. In [9], condition monitoring techniques were reviewed, respectively, from off-line and on-line viewpoints. In [10], condition monitoring techniques for wind turbines were overviewed with discussions on trends and challenges in wind turbine maintenance. In [11], typical faults in wind turbines were discussed and structure condition monitoring and fault diagnosis approaches were inspected. Off-shore wind turbines have received much more attention in wind turbine industries recently, owing to high capability for power generations. In [12], health monitoring and safety evaluation for off-shore wind turbines were surveyed with a focus on blades, tower, and foundation in off-shore wind turbine systems. In [13], wind turbine main bearings were reviewed from the angles of design, operation, modeling, damage mechanism, and corresponding fault diagnosis methods. In the two-part survey papers [14,15], wind turbine components and their potential faults, and fault diagnosis algorithms were reviewed from the viewpoint of signal processing. In [16], machine learning based condition monitoring and diagnosis approaches were surveyed. In [17], an overview was presented for condition monitoring, fault diagnosis, and operation control (including online maintenance and fault tolerant control) on electric power conversion systems in direct-drive wind turbines. In [18], major failures in off-shore wind turbines such as grid failure, yaw system failure, electrical control failure, hydraulic failure, blade failure, and gearbox failure, were discussed and possible prognosis approaches for the failures were commented. For low-speed bearings and multistage gearbox faults in wind turbines, diagnosis and prognosis approaches were overviewed in [19] according to the applicability to wind turbine farm-level health management. In [20], a concise and specific review was carried out on prognosis and remaining useful life estimation methods for critical components in wind turbines. In [21], a state-of-the-art review for fault prognosis and predictive maintenance was documented. In [22], a brief review for fault tolerant control approaches in wind turbine systems was provided. In [23], a concise review was given on diagnosis, prognosis, and resilient control for wind turbine systems. From Table 1, one can see the majority of the review papers was focused on condition monitoring and fault diagnosis, and there were very few overview papers dealing with prognosis and resilient control. Moreover, the survey papers mainly concentrated on single topic, either diagnosis or prognosis or resilient control. It is noted that [23] was a unique review paper covering all the monitoring and diagnosis, prognosis, and resilient control. However, [23] is actually editorial review for 23 papers included in a special issue. Consequently, this motivates us to provide a comprehensive review on fault diagnosis, prognosis, and resilient control for wind turbine systems in a single paper, which would benefit the readers to appreciate the current state of the art of health monitoring and management and control in wind turbine conversion systems.

Table 1. Review papers on monitoring and diagnosis, prognosis, and resilient control for wind energy systems.

Years	Monitoring and Diagnosis	Prognosis	Resilient Control
2000s	[3,4,6,7]		
2010s	[5,8–17,23]	[18–21,23]	[17,22,23]

The rest of this paper is organized as follows: In Section 2, the structure and typical faults of wind turbines are introduced, and the schematic methodologies of fault diagnosis, prognosis and resilient control are illustrated briefly. Section 3 presents a comprehensive survey of condition monitoring and fault diagnosis methods of wind turbines in terms of four categorizations from the viewpoint of different types of information redundancy, namely, model-based techniques, signal-based techniques, knowledge-based techniques, and hybrid techniques. Recent development of wind turbine prognosis and resilient control approaches will be reviewed in Sections 4 and 5, respectively. Finally, Section 6 concludes the work and proposes an overlook about future research about maintenance operation of wind energy systems.

2. System Overview and Fault Modes of Wind Turbines

A wind turbine system is a complex electromechanical system that converts wind energy to electrical energy. A wind turbine constitutes various subsystems and components such as blades, rotor, gearbox, generator, yaw, tower, controller, anemometer, break, and so forth. A typical structure of a wind turbine system is shown in Figure 1. Wind flows force the blades and rotor to run, which rotates the main shaft and speeds up through the gearbox to drive the generator, converting wind energy into mechanical energy, and further to electrical energy. Pitch angles can be regulated to adapt the change of wind speed, while the yaw system can align turbine with the direction of the wind identified by the anemometer. The controller is used to ensure to generate desired electricity, and the housing (or “nacelle”) is mounted at the top of a tower to cover most of these components.

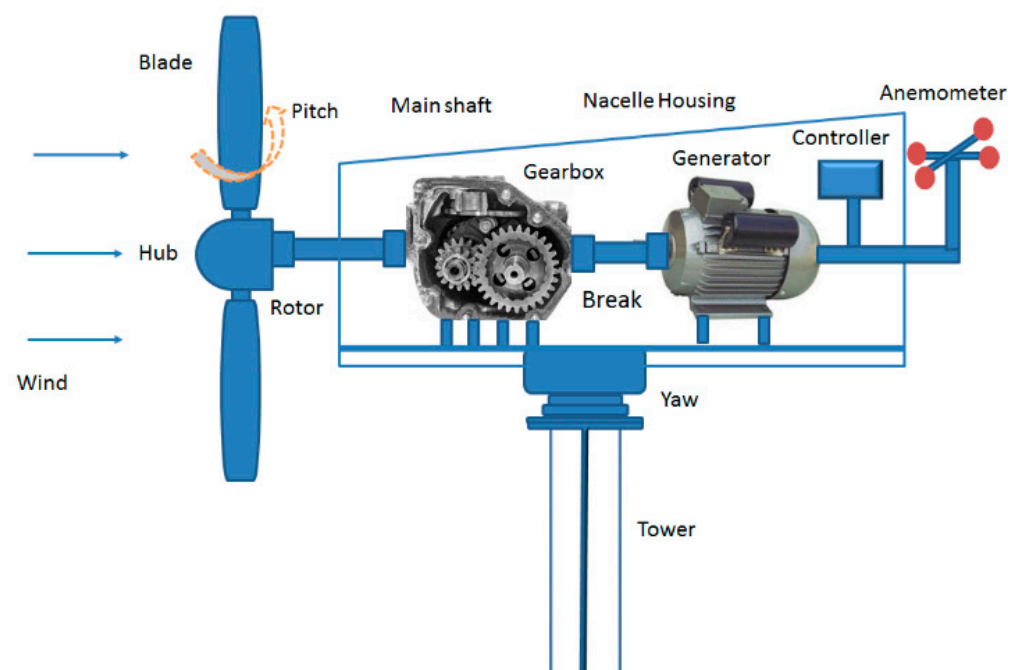

Figure 1. Wind turbine systems.

In practice, wind turbine components are prone to malfunctions or faults due to either ephemeral events or aging degradation, leading to system interruptions and economic

losses. Unexpected abnormal behaviors of wind turbines can be categorized into faults and failures. A fault is recognized as an unacceptable deviation of the system structure or the system parameters from the nominal situation, whereas a failure is defined as inability of a system or a component to fulfil its function [24,25]. The pie chart in Figure 2 shows the percentages of the typical faults in wind turbines, and the main causes of the typical faults are summarized in Table 2. If an unexpected fault is not detected in the early stage and a timely action is not taken, it may cause consequent failures.

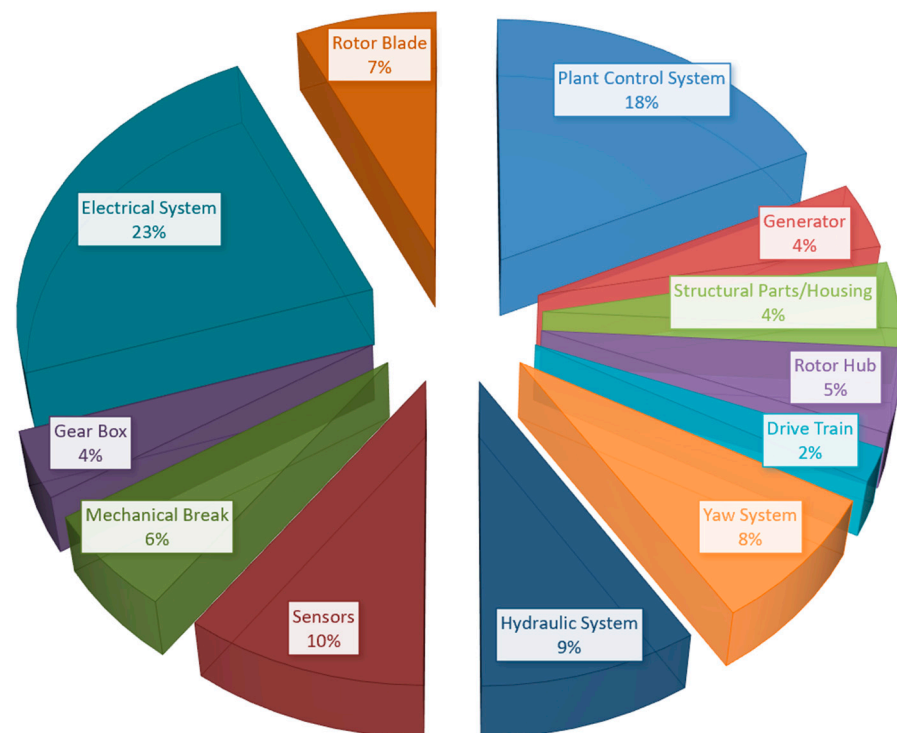

Figure 2. Percentages of typical faults in wind turbines [26].

Table 2. Typical faults in wind turbines [1,14,18].

Types of Faults	Causes of Faults
Faults on blades and rotors	Corrosion of blades and hub; crack; reduced stiffness; increased surface roughness; deformation of the blades; errors of pitch angle; and imbalance of rotors, etc.
Faults on gearbox	Imbalance and misalignment of shaft; damage of shaft, bearing and gear; broken shaft; high oil temperature; leaking oil; and poor lubrication, etc.
Faults on generator	Excessive vibrations of generator; overheating of generator and bearing; abnormal noises; and insulation damage, etc.
Faults on bearing	Overheating; and premature wear caused by unpredictable stress, etc.
Faults on main shaft	Misalignment; crack; corrosion; and coupling failure, etc.
Hydraulic faults	Sliding valve blockage; oil leakage, etc.
Faults on mechanical braking system	Hydraulic failures; and wind speed exceeding the limit, etc.
Faults on tower	Poor quality control during the manufacturing process; improper installation and loading; harsh environment, etc.
Faults on electrical systems/devices	Broken buried metal lines; corrosion or crack of traces; board delamination; component misalignment; electrical leaks; and cold-solder joints, etc.
Faults on sensors	Malfunction or physical failure of a sensor; malfunction of hardware or the communication link; and error of data processing or communication software, etc.

It is noticed that wind turbine generators can be classified into gear-box coupled wind turbine generators (e.g., doubly-fed induction generators) and direct-drive wind turbine generators (e.g., permanent-magnet synchronous generators). Although Figures 1 and 2 and Table 2 include gearbox, this survey paper will review fault diagnosis, prognosis, and resilient control approaches for both geared and gearless wind turbine systems.

Condition monitoring is defined as a process to monitor operation parameters of machinery in order to identify significant changes as an indication of a developing fault. Fault diagnosis aspires to detect the occurrence of faults, locate the faulty components, and identify the types, magnitudes, and patterns of the faults at an early stage, and the three tasks aforementioned are named as fault detection, fault isolation, and fault identification, respectively. Prognosis aims at predicting remaining operation time before faults result in failures, while resilient control is to design control laws such that the adverse influences from faults can be mitigated, ensuring the system to work normally even under faulty conditions, which may not necessarily induce an immediate component replacement or repairing for non-vital faults. The schematic diagram of the three issues is illustrated in Figure 3, where f_a , f_c , and f_s denote actuator faults, process or component faults, and sensor faults, respectively; v , u , and y are, respectively, the reference inputs, control inputs and measurement outputs. Based on recorded input and output data, fault diagnosis can be implemented to detect and locate the faulty components. The recorded data can be further used for fault prognosis and remaining useful life prediction. Based on fault diagnosis and prognosis information, resilient controls and decisions can be carried out to mitigate the adverse influences from the faults. By implementing appropriate fault diagnosis, prognosis, and resilient control strategies, the reliability and safety of wind turbine systems can be enhanced, and the maintenance cost and downtime can be reduced, which are of significant importance to achieve economic operation and increase productivity.

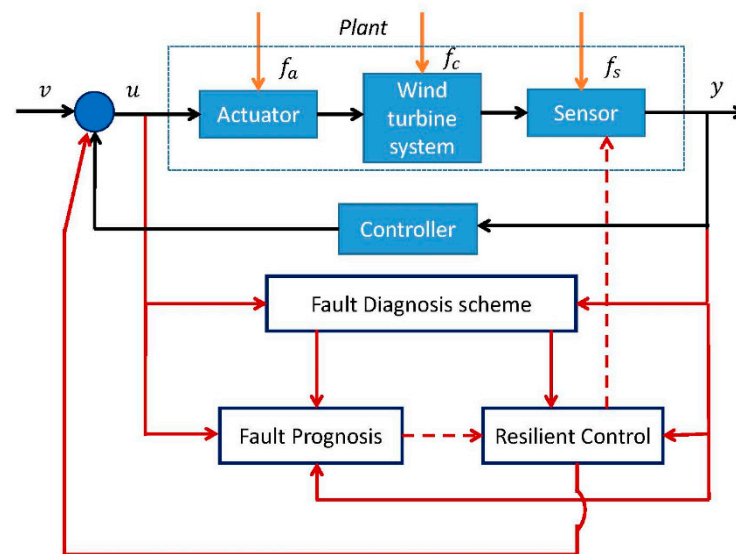

Figure 3. Schematic diagram of fault diagnosis, prognosis and resilient control.

3. Fault Diagnosis of Wind Turbines

Condition monitoring aims to check operation parameters of wind turbines to provide an early indication of faults, and fault diagnosis is conducted to detect, locate, and identify occurring faults, which allows us to plan system repair strategies prior to complete failures. Condition monitoring is actually kind of fault detection, therefore in this paper we will survey condition monitoring and fault diagnosis within a framework. From the viewpoint of different types of the information redundancy, fault diagnosis can be categorized into mode-based methods, signal-based methods, knowledge-based methods, and hybrid methods by combining the three above-mentioned methods.

3.1. Model-Based Fault Diagnosis for Wind Turbine Systems

Model-based fault diagnosis is suitable for non-stationary operation for wind turbines. This method requires models of wind turbine systems established by using either physical principles or systems identification techniques. In [27], a versatile wind velocity model was established, delivering a capability of simulating a wide range of wind variations and usual disturbances. In [28], a dynamic model was derived to simulate a doubly fed induction generation (DFIG) wind turbine with a single-cage and double-cage description of the generator rotor, and a characterization of its control and protection circuits. In [29], an industrial standard simulation tool, namely PSCAD/ EMTDC, was used to address dynamic modeling and simulation of a grid connected variable speed wind turbine. A 4.8 MW wind turbine benchmark model was originally addressed in [30] for a generic three-blade horizontal variable speed wind turbine with a full converter coupling, and the model was described with more detail in [31]. Based on wind turbine modeling software FAST, a 5MW enhanced wind turbine benchmark model was built in [32] by considering more realistic wind inputs and nonlinear behavior of aerodynamics. The wind turbine models have facilitated the development and applications of model-based fault diagnosis for wind turbine systems.

A schematic diagram of model-based fault diagnosis is depicted by Figure 4. The basic idea for model-based fault diagnosis is to provide the same inputs to the real-time wind turbine and wind turbine model, and monitor the differences between the real-time wind turbine outputs and model outputs. If the difference or called residual is zero or less than a preset threshold, the wind turbine is under healthy conditions. Otherwise, the real-time wind turbine outputs are inconsistent with the model outputs, which indicates a fault occurs in wind turbine systems. It is noticed that wind turbine models usually suffer modeling errors, and real-time turbine systems are subjected to external disturbances and varying loads, the aforementioned simple detection strategy may cause considerable false alarm rate. In order to reduce false alarm rate and improve fault detection and diagnosis performance, great efforts were paid to developing effective diagnosis algorithms so that the residual was sensitive to faults but robust against modeling errors and external disturbances.

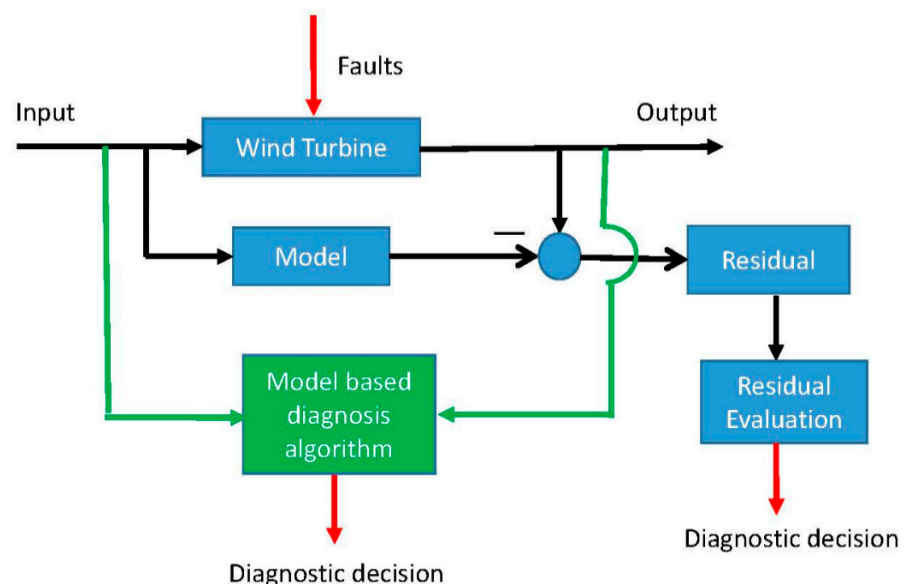

Figure 4. Schematic diagram of model-based fault diagnosis.

One of the most popular approaches is observer based fault detection approach. The key idea is to design an observer to estimate the model output, and monitor the residuals between the wind turbine outputs and the estimated model outputs. Optimization approaches are used to find a suitable observer gain to enhance the fault effects on the residuals but attenuate the influences from uncertainties to the residuals. In [33], a Lu-

enberger observer based fault detection algorithm was addressed to detect actuator and sensor faults for a linearized 3MW wind turbine system, where parameter eigenvalue assignment approach and evolutionary algorithm were amalgamated to search an optimal observer gain so that the residual was sensitive to faults but robust against noises and perturbations. In [34], a fault diagnosis method was presented for multiple open-circuit faults in back-to-back converters of a permanent magnet synchronous generator (PMSG) drive for wind turbine systems where a Luenberger observer and adaptive threshold were used to ensure a reliable diagnosis independent of drive operation conditions. Motivated by the challenges to handle nonlinearities and partially known properties, which are difficult for mathematical modeling of wind turbines, Takagi-Sugeno (T-S) fuzzy models have drawn much attention by approximating nonlinear dynamics by using weighted aggregation of a set of linear models valid around selected operating points, such that the complexity of the nonlinear problems can be decreased to linear range. In [35], a T-S fuzzy model was established for a 4.8 MW benchmark wind turbine, and the corresponding residual based fault diagnosis methodology was developed based on developed fuzzy representation. In [36], a T-S fuzzy model was built for a 4.8 MW wind turbine system, and a fault estimator was addressed to estimate actuator and sensor faults, where an augmented system approach, robust observer technique, and linear matrix inequality optimization method were integrated to ensure a robust fault estimation for generator torque actuator fault and rotor speed sensor fault against modeling errors and noises. Time-varying model has been a powerful alternative to describe wind turbine system dynamics. In [37], a time-varying model was created for a 4.8 MW wind turbine system where the blade pitch angle, tip-speed ratio, and rotor speed were the scheduling parameters to be updated real-time. Based on the time-varying model, an augmented time-varying observer was addressed to estimate parameter fault and actuator fault in wind turbine systems. In [38], internal model was used to describe wind turbine dynamics where uncertainties were located in the parameters bounding their values by intervals. Internal observers were then designed for a 5 MW wind turbine system, and fault detection was achieved by checking if the real-time measurements fall inside the estimated output interval.

In parallel with the observer, Kalman filter also plays an important role in fault detection and diagnosis for wind turbine systems where process and measurement noises are assumed to be random since wind turbine dynamics are more or less subjected to random noises in either wind speed or measurements. Kalman filter has a similar structure with observers, associated with various statistic tools (e.g., generalized likelihood ratio test), the nature of the faults can be extracted by testing on whiteness, mean, and covariance of the residuals [39]. In [40], for a three-blade horizontal axis wind turbine, a system identification algorithm was used to establish a state-space linearized model, and a Kalman filter based diagnosis algorithm was then addressed to detect additive and multiplicative sensor faults. Cascaded Kalman filters were addressed in [41] to detect faults in wind turbines which can achieve fast detection but may fail under low fault-to-noise signal ratio scenario. In order to capture more accurate means and covariance of faults, unscented Kalman filter [42] was employed to identify three fault modes, namely, gearbox faults, lubrication oil leakage, and pitch damages.

The parameter estimation approach was based on the assumption that the faults were reflected in the physical parameters, such as oil temperatures and electrical voltages of the systems. In this approach, residuals are computed as the parameter estimation errors, which are used to check the consistency of the estimated parameters with real process parameters. [43] presented an adaptive parameter estimation based fault diagnosis method to detect and isolate faults in wind turbine hydraulic pitching systems. In [44], a nonlinear parameter estimation approach was addressed for wind turbine generators by monitoring temperature trend. This method is straightforward if the model parameters have an explicit mapping with the physical coefficients. However, the diagnostic performance strongly depends on the accuracy of the measured parameters, which would be a constraint of this approach.

3.2. Signal-Based Fault Diagnosis for Wind Turbine Systems

Signal-based methods rely on appropriate sensors installed in wind turbines, rather than explicit input–output models. Sensors measure wind turbine signals such as electrical signals, vibration, and sound signals. Signal processing techniques are used to extract symptoms which are highly reflected by corresponding faults. The symptoms of real-time signals are checked with the symptoms of healthy signals from prior knowledge and experiences so that a diagnostic decision can be made. A schematic diagram is shown in Figure 5 to describe signal-based fault diagnosis approach. In general, signal-based fault diagnosis can be classified into time-domain method, frequency-domain approach, and time-frequency technique.

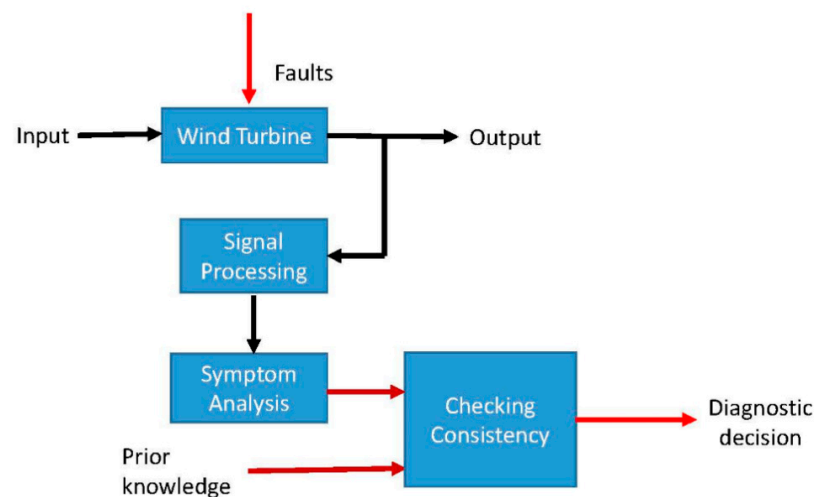

Figure 5. Schematic diagram of signal-based fault diagnosis.

Time-domain signal-based fault diagnosis utilizes time-domain parameters reflecting component malfunctions or failures such as root mean square, peak value, and kurtosis straightforwardly to monitor wind turbine dynamics. In [45], a fault diagnosis approach for multiple open-circuit faults in two converters of permanent-magnet synchronous generator drives for wind turbine application was presented by using the absolute value of the derivative of the Park's vector phase angle as a fault indicator.

Frequency-domain signal-based fault diagnosis approaches use a variety of spectrum analysis techniques, such as discrete Fourier transformation (DFT) which can be calculated by using fast Fourier transformation (FFT) [46,47], to transform a time-domain waveform into its frequency-domain equivalence, consequently used for monitoring and fault diagnosis. In [46], a two-stage fault diagnosis algorithm for wind turbine gearbox was addressed, where FFT was utilized to convert raw time-domain vibration signals to frequency spectrum, and kurtosis values were used to compute severity factors and levels by comparing with desired frequencies of the non-fault conditions. In [47], gear tooth damages were detected by checking gear vibration spectra.

In order to improve the processing ability for signals, time-frequency analysis approaches, by combining both time-domain waveform and corresponding frequency spectrum, have received much attention. In condition monitoring and fault diagnosis of wind turbines, commonly used time-frequency analysis techniques include wavelet transforms [48–50], Hilbert transform [51,52], Wigner–Ville distribution (WVD) [53], and short-time Fourier transform (STFT) [54], and so forth. Wavelet transform is applicable to non-stationary signals to enhance signal-to-noise ratio (SNR). Continuous wavelet transform was used for faulty symptom extraction, while discrete wavelet transform was employed to achieve noise cancellation in [48,50]. Hilbert transform is usually combined with other tools, such as Empirical Mode Decomposition (EMD) and time synchronous average (TSA) to reduce the influences from noises and uncertainties. Specifically, Hilbert–Huang trans-

forms (HHT), which is an improved scheme by employing Hilbert transform and EMD, was utilized in [51] to detect gear-pitting faults. [52] utilized a time synchronous average (TSA) to extract periodic waveform from noisy signals in vibration signals when faults were detected by Hilbert transform. STFT and TSA were combined in [54] and spectral kurtosis was used to detect tooth crack faults. In practice, the aforementioned methods are often jointly used to achieve better diagnosis performances. For example, [53] proposed Morlet continuous wavelet transforms to handle extra noises and Smoothed Pseudo Wigner–Ville distribution (SPWVD) spectrum to cope with cross terms. Taking both advantages of wavelet transform and EMD, empirical wavelet transform (EWT) was adopted in [55] for generator bearing fault diagnosis.

Signal-based monitoring methods do not need to establish an explicit of mathematical model for wind turbine system. It is easily implemented by using various signal processing techniques. In general, it is suitable for monitoring and diagnosing rotating components of wind turbines, such as wheels and bearings of gearbox, bearings of generator and main bearing.

3.3. Knowledge-Based Fault Diagnosis for Wind Turbine Systems

Different from model based and signal based diagnosis methods which rely either prior mathematical model or known signal pattern, knowledge-based approach relies on a large volume of historical data available and symbolic and computational intelligence techniques to extract knowledge base, representing dependency of system variables explicitly. A diagnostic decision is made by checking the consistency between the knowledge base and the real-time operation behavior with the help from a classifier. The schematic diagram of knowledge-based fault diagnosis is shown in Figure 6. From the perspective of extraction process of historical knowledge, knowledge-based fault diagnosis methods can be classified into qualitative approaches and quantitative approaches.

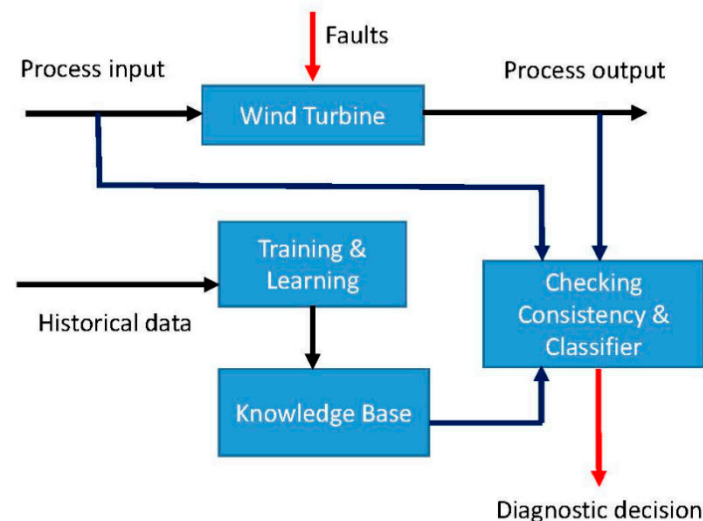

Figure 6. Schematic diagram of knowledge-based fault diagnosis.

A Root cause and fault tree analysis approach and expert system-based method can be generally regarded as qualitative knowledge approaches for condition monitoring and fault diagnosis [56,57], which have been successfully applied to wind turbines systems [58–61]. Specifically, [58] utilized fault tree analysis to describe a set of potential system failures, and cost-priority-number values were calculated to evaluate the severity of faults. In [59], a fuzzy fault tree analysis approach was addressed for risk and failure mode analysis in offshore wind turbine systems, where expert knowledge was expressed using fuzzy linguistics terms, and grey theory analysis was then integrated to determine the risk priority of the failure modes. In [60], fault tree analysis was employed to identify possible causes of top event, and expert system was then designed to implement diagnosis for gear box in a

wind turbine. In [61], a fuzzy expert system was introduced by setting rules to determine the levels of faults of wind turbine gear box.

Quantitative, knowledge-based methods can be either statistical-analysis-based or non-statistical-analysis-based. Due to using a large amount of historical data, knowledge-based approaches here are often called data-driven approaches. Commonly used statistical data-driven fault diagnosis techniques include principal component analysis (PCA) [62], independent component analysis (ICA) [63], subspace aided approach (SAP) [64], fisher discriminant analysis (FDA) [65], and support vector machine (SVM) [66,67], and so on. The basic idea for PCA, ICA, SAP, and FDA is to use a variety of dimensionality reduction approaches to preserve significant trends of original data set in order to achieve promising results in fault extraction. The SVM is a nonparametric statistical method which can be used to capture faulty response of wind turbines owing to its excellence capability for classification. In [66], least squares SVM was used to train function of weather and turbine response variables; and distinguish faulty conditions from healthy conditions. Associated with appropriate nonlinear kernels tested on dataset, statistical-analysis-based approaches can attain more accurate and reliable identifications. For instance, in [67], a comparative study was carried out to demonstrate advantages of a kernel-based SVM diagnosis approach in wind turbines compared with traditional methods. In addition to statistical data-driven diagnostic techniques, non-statistical approaches, such as neural network (NN) [68,69] and fuzzy logic (FL) [70], are widely used to carry out fault diagnosis and condition monitoring for wind turbines. FL is an approach of partitioning a feature space into fuzzy sets and utilizing fuzzy rules for reasoning, which can essentially provide approximate human reasoning. Cluster center fuzzy logic approach was used in [70] to estimate wind turbine power curve. A well-trained NN has an ability of making intelligent decisions even when noises, system disturbances, and corrupted data are present. In [71], a deep neural network based fault detection approach was presented for direct-drive wind turbine systems. In [72], a fault diagnosis algorithm was proposed by using multiple extreme learning machines (ELM) layers to achieve feature learning and fault classification.

The aforementioned statistic and non-statistic data-driven fault diagnosis techniques have their own advantages and disadvantages. In practice, these methodologies are often used jointly. For instance, FL-based methods require extensive expert knowledge of the system, which may be difficult to be derived. NN is ideal for situations like this, where the knowledge, describing the behavior of the system, is stored in a large volume of quantitative datasets. However, the output is difficult to back-track due to the black-box data processing structure which causes slow convergence speed. Recent developments have shown an interest in adaptive Neuro-Fuzzy Inference System (ANFIS) to integrate these two methods, so that better fault diagnosis performances can be achieved. The joint method, addressed in [73], proved to be faster than NN in monitoring abnormal behaviors in wind turbines. Additionally, several data-driven algorithms, including PCA, k-nearest neighbor algorithms, and evolutionary strategy were combined to monitor operation of a wind farm in [74].

3.4. Hybrid Fault Diagnosis for Wind Turbine Systems

Model-based fault diagnosis method has excellent fault detection, fault isolation, and fault identification capability from a system level when a system model is available. Due to the nature of off-line design and on-line implementation, model-based fault diagnosis approach has excellent real-time performance. Signal-based approaches are independent of explicit mathematical models, which mainly focus on measurement outputs and require less knowledge about input signals. Nevertheless, it is not realistic to install sensors on all components of wind turbines from the viewpoint of economic cost, and space and weight consideration. Knowledge-based (data-driven) approaches rely on historical data and symbolic and computational intelligence, and supervisory control and data acquisition (SCADA) and smart sensors equipped in wind farms make data-driven approach feasible and attractive. It is noted that it is time consuming for training and learning. Recently,

hybrid approaches by adopting more than one of the approaches are usually used to enhance fault diagnosis performance for wind turbines.

In [75], FFT was used to spot the main frequency of disturbances, and evolutionary algorithm was employed to seek an optimal observer gain to minimize the effects in the estimation error from dominant disturbances as well as low-frequency faults so that a robust fault estimation algorithm was developed for a 5 MW wind turbine system. The work in [75] is a combination of signal-based and model-based methods.

In [76], artificial neural network was used to estimate nonlinear term in wind turbine model, and linear matrix inequality optimization was addressed to find an optimal observer gain so that a robust actuator fault estimation was achieved for 4.8 MW wind turbine Benchmark system. In [77], fault detection and isolation for wind turbines were addressed by using a mixed Bayesian/Set-membership, where modeling errors were described as unknown but bounded perturbations from the viewpoint of set membership method, while measurement noises were characterized as bounded noises following a statistical distribution. The approaches in [76,77] are actually a hybrid of model-based and data-driven approaches.

Vibration signals in rotational parts of wind turbines are nonstationary and non-Gaussian, and fault samples are usually limited. In order to solve the issue above, [78] proposed a fault diagnosis algorithm based on diagonal spectrum and SVM where diagonal spectrum can be used to extract fault features from the vibration signals, and SVM can realize fault classification effectively. In [79], FFT method and uncorrelated multi-linear principal component analysis technique were integrated to achieve an effective three-dimensional space visualization for fault diagnosis and classification under five actuator and sensor faulty scenarios in a 4.8 MW wind turbine benchmark system. The methods of [78,79] are essentially a hybrid of signal-based and data-driven based approaches.

4. Prognosis for Wind Turbine Systems

Prognostics is a process to predict the progression of a deviation of a system from expected normal operating condition into a failure and estimate the remaining useful life of wind turbines. Based on various fault diagnosis and condition monitoring strategies, health status of wind turbines can be assessed and degradation patterns can be indicated, which allow a prognostic scheme to be introduced to predict when machine will fail. A schematic diagram of fault prognosis is depicted in Figure 7. When a system performance degradation (i.e., the performance departs from the normal performance) is recognized, remaining useful life (RUL) estimation will be implemented. Prognosis approaches can be generally classified into model-based, data-driven, and hybrid approaches. Model-based prognosis methods use physical and mathematical expressions to describe the degradation trend, and identify the performance degradation from real-time monitoring, and estimate the RUL of wind turbines. Data-driven approaches use historical data and machine learning techniques to train and learn system performance dynamics, identify current performance degradation from real-time data, and predict the RUL of wind turbines. Hybrid approach is a combination of the two approaches in order to obtain a better prognosis.

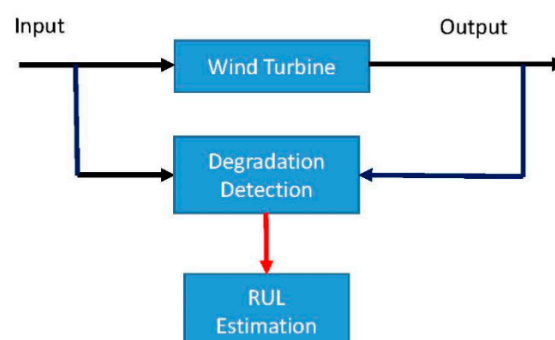

Figure 7. Schematic diagram of fault prognosis.

4.1. Model-Based Prognosis for Wind Turbine Systems

As wind turbines are subject to strongly varying loads which make the components fatigue during operation, predicting their reliable lifetime is of significance. Different fatigue models for lifetime prediction were proposed, including fatigue life models [80,81] and progressive damage models [82,83]. Fatigue life models are based on a well-known S–N curve to describe allowable cycles of failures. Prediction of fatigue life from the random load spectrum was addressed in [80,81] for medium-scale and small-scale wind turbine blades, respectively, using S–N curves. In progressive damage models, variables that describe the deterioration of the composite component were selected to assess damages. [82] presented a reduced order model to predict the occurrence and progression of damages in blades by integrating Thine-wall beam and progressive failure analysis. A progressive damage model, based on the cohesive zone concept with mixed-mode bilinear constitutive law, was addressed in [83] for analyzing fatigue of the adhesive joint root of the wind turbine blades. In [84], a probabilistic damage-growth model was utilized to characterize performance degradation of individual wind turbine, and failure prognosis informed decision-making tool was developed.

4.2. Data-Driven Prognosis for Wind Turbine Systems

One promising data-driving technique for prognosis of wind turbines is adaptive neuro-fuzzy inference system (ANFIS), which is a hybrid learning algorithm by integrating the best features of fuzzy systems and artificial neural networks. [85,86] developed ANFIS-based pitch faults prognosis for a wind farm composed of 26 wind turbines, incorporated by a priori knowledge of six known faults to train the system. Artificial intelligence systems, by integrating fuzzy logic, neural networks, and expert systems, were utilized for predictive maintenance of the wind turbine gearbox in [61]. Another popular methodology for prognosis successfully implemented in wind conversion systems is genetic algorithm (GA), inspired by Darwinian evolutionary models, which was used in [87], such that blade pitch faults can be predicted 5–60 min in advance. Moreover, a number of data mining approaches, consisting of NN, ensemble NN, standard classification, and regression tree, boosting tree algorithm, and SVM were cooperated in [88] to achieve fault prediction at three levels, namely, identification of existence of a fault, prediction of the severity of the fault, and prediction of specific fault.

4.3. Hybrid Prognosis for Wind Turbine Systems

Since prognosis of a problem is more challenging than diagnosis, it is common to integrate different types of approaches. For instance, in [89], a model was derived to describe mathematical relationship between lubrication, oil degradation, and particle contamination level, and a particle filtering technique-based RUL prediction tool was used to achieve lubrication oil prognosis by means of predicting state values in terms of probability density function (PDF). This method is a hybrid of model-based and data-driven method.

5. Resilient Control of Wind Turbine Systems

Resilient control strategies aim to mitigate the influences from unexpected faults (rather than failures) or unexpected dynamics (e.g., unknown delays) such that the overall function of the wind turbines can be maintained, although the operation and production performance may be reduced but tolerated. There are two types of resilient control approaches: passive resilient control and active resilient control.

A schematic diagram of resilient control for wind turbines is depicted by Figure 8, where f_a , f_c , and f_s denote the actuator faults, parameter (or process) faults, and sensor faults, respectively. In passive resilient control, a fixed controller is designed that tolerates all considered faulty conditions (or abnormalities) of the plant. This approach requires no on-line detection of the abnormalities, and is therefore more attractive computationally. However, a passive resilient control would be invalid if an unexpected abnormality occurred that was not considered in the design. In active resilient control, the controller is

reconfigured by control laws that react to abnormalities based on information extracted by real-time monitoring and diagnosis scheme. Once a fault or abnormality is identified, effective configuration strategies can be conducted to attenuate the impact of the abnormalities on the wind turbine systems.

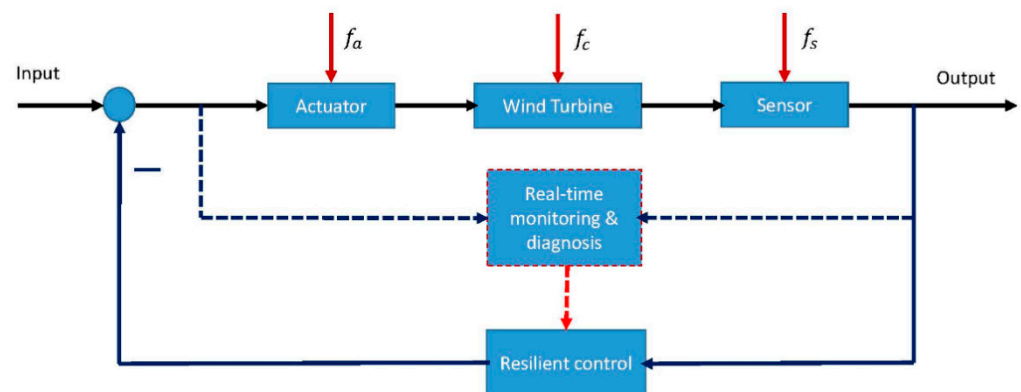

Figure 8. Schematic diagram of resilient control.

5.1. Passive Resilient Control

In [90], a passive resilient control strategy was addressed to avoid saturation caused by potential faults in 5MW wind turbine, and the key idea used was to manipulate the reference power and generator speed set-points hysterically. In [91], wind turbine system was described by linear parameter varying (LPV) system, and a robust control strategy was developed so that the system was resilient against a fault in a pitch system without need of the information from monitoring and fault diagnosis. In [92], a passive, fault tolerant cooperative control scheme was presented for a wind farm under power generation faults where fuzzy model reference control was used in a cooperative framework. In [93], a robust super-twisting algorithm-based control scheme was designed for a large floating offshore wind turbine disrupted by wind turbulence and pitch actuator faults, so that a tolerant operation was procured.

5.2. Active Resilient Control

Fault estimation and compensation have proven a powerful tool for resilient control design and implementation. In [36], a 4.8MW wind turbine system was approximated by a Takagi-Sugeno fuzzy model. By using an augmented unknown input observer, actuator and sensor faults were estimated, and signal compensation techniques were used to mitigate the effects from the actuator faults on the system dynamics and the influences of the sensor faults on the system outputs. It was proved and demonstrated that the existing controllers with compensation can ensure a tolerant operation of the wind turbine under predefined low-frequency actuator and sensor faults. The approach in [36] can deliver both real-time fault diagnosis (fault estimation) and resilient control, but there is no need for an on-line control update. A hydraulic press drive unit may cause unknown delays of the pitch dynamics, which has adverse effects on wind turbine operation performance. In [94], an augmented observer was proposed to estimate a perturbed term caused by unknown delays of the pitch system, and a sensor compensation technique was addressed to mitigate the adverse effect of the unknown delay on the pitch output dynamics in a 4.8 MW wind turbine system. In [95], a disturbance observer was addressed to estimate pitch actuator fault, and a fault tolerant control with actuator compensation was designed to achieve tolerant operation of a 5MW wind turbine, under a pitch actuator fault. In [96], an adaptive sliding mode observer was addressed to estimate a pitch actuator fault in a wind turbine, and the estimated fault signal was used to compensate the effects from the actuator fault. In [97], a perturbation observer was used to estimate time-varying external disturbances including grid faults, voltage dips, and intermittent wind power inputs, and a

nonlinear adaptive control with compensation was used to enhance the fault ride-through capability for a full-rated converter wind turbine. In [98], an adaptive sliding mode tolerant controller with compensation was addressed to alleviate the fluctuations in rotor speed, generator speed, and generator power under faulty conditions in a 5MW wind turbine system. In [99], an adaptive tolerant control algorithm, with the aid of fault estimation, was presented for wind turbines subjected to effectiveness loss faults in pitch actuators. In [100], a tolerant control strategy was proposed for wind turbine systems under bias faults of converter actuators in a 2 MW wind turbine system, in which fault detection and estimation were achieved by using residual filter and fault estimator, and receding horizon control technique was used to reconfigure control parameters so that the turbine health such as maximum power and less fatigue reduction was attained under faults.

In [101], a resilient configuration of doubly fed induction generator (DFIG) in 1.5 MW wind turbine was addressed to achieve tolerant operation under various kinds of grid faults, where nine-switch converter was used to replace conventional six-switch converter, and appropriate control algorithm was designed to ensure a seamless fault-ride through under grid faults. Power converter is recognized as one of the most fragile parts in wind turbine conversion systems, which contributes about 14% of the downtime of a wind turbine. In [102], a fault-tolerant operation strategy against switch faults was addressed where an additional power switch leg was used to replace a faulty leg using fault diagnosis information and corresponding control algorithms. In [103], a fault tolerant control method was addressed for direct-drive wind turbine systems under open circuit faults in machine side converters by regulating SVPWM switching patterns. It is evident that the aforementioned techniques are model-based active resilient control techniques.

In [104], a data-driven resilient control approach was addressed for a wind turbine benchmark system. Specifically, a residual generator was constructed directly identified from the input and output data, which should be sensitive to faults. The residual was embedded into the control loop to mitigate the effects from the faults and achieve tolerant operation performance under faulty conditions. In [105], a data-driven fault tolerant control scheme was presented for wind turbine systems in which the residual generator was included in the control loop so that the key performance indicator (e.g., the quality of produced power) was maintained in the admissible range under faulty conditions. In [106], a data-driven fault tolerant control approach was developed for 10 MW off-shore wind turbines, where a subspace algorithm was employed to identify a linearized-dynamics of the wind turbine, and an adaptive repetitive control law was formulated to mitigate faulty induced loads.

6. Conclusions and Overlook

The presented paper has provided a comprehensive survey covering three crucial topics, namely fault diagnosis, prognosis, and resilient control, of wind turbines, which are beneficial to maintain operation, improve energy productivity, prolong the life of usage and enhance system safety.

For fault diagnosis, it has been reviewed following the categories of model-based, signal-based, knowledge based, and hybrid approaches. Model-based monitoring and diagnosis approaches need a mathematical model to describe explicit relationships between system inputs and outputs in wind turbine systems, which are effective and powerful to carry out real-time monitoring and fault diagnosis from a system level. How to develop an accurate mathematical model and how to enhance the robustness of the model-based fault diagnosis algorithms against modeling errors and external disturbances, and sensitivity to the faults monitored are the key factors for model-based fault diagnosis approaches. Owing to off-line design, and on-board implementation, model-based monitoring, and fault diagnosis algorithms have excellent real-time performance. Signal-based monitoring and diagnosis approaches do not need system models, but rely on measurement signals from sensors, which are convenient for implementation. The measured signals are mainly dependent on system outputs, but with less attention on inputs, signal-based approaches would

be sensitive to external disturbances and load changes. Knowledge-based approaches do not need to establish an explicit mathematical model, but use historical data to train and search in order to represent an implicit relationship among the variables. Knowledge-based approaches are effective for monitoring and diagnosis for both system-level faults and structural faults in wind turbines. A knowledge-based approach is highly dependent on the quality of the recorded data, and is time-consuming for training and searching. The three approaches above have own advantages and disadvantages, it would be a better solution to integrate them to lead a hybrid design and implementation to achieve a reliable and effective monitoring and diagnosis for wind turbines.

For prognosis and remaining useful life prediction, it has been reviewed following model-based, data-based, and hybrid approaches. Model-based method needs to derive an explicit physical or mathematical expression to describe the performance degradation trend, and the remaining useful life is estimated once upon the performance degradation status is identified by real-time monitoring. A model-based method needs a thorough understanding on how a physical parameter or symptom relates the performance degradation. Data-driven methods rely on historical run-to-failure data, but do not need a mathematical model. It would be difficult to obtain sufficient and reliable run-to-failure data in practice, particularly for wind turbines as they are expensive, and the machines generally stop before a collapse happens. It would be a better solution to integrate model-based and data-driven based prognosis approaches for an effective and reliable fault prediction. Compared with condition monitoring and fault diagnosis approaches, prognosis and remaining useful life estimation need much more research and development due to the complexity of wind turbine systems.

For resilient control, it has been surveyed following the categories of passive resilient control method and active resilient control method. Passive resilient control approaches do not need the information of healthy status in wind turbines, but design a robust controller so that the stability and operation of wind turbines are robust against both disturbances and faults. Resilient passive control is simple to implement, but generally has limited tolerant capabilities to accommodate faults. Active resilient control approaches need the information from real-time monitoring and fault diagnosis, and the controllers are reconfigured to mitigate the adverse effects from the faults, and achieve a tolerant operation performance. Active resilient control approaches are more attractive as they are integrated with fault diagnosis, which can effectively adapt to faulty conditions by appropriate control configurations in terms of monitored faults. It is noticed that the majority of resilient control approaches for wind turbines systems are model-based, and only a few works use data-driven approaches. It is encouraged to develop data-driven based resilient control approaches for wind turbine systems with the aid of large amount of data available and machine learning techniques.

Recently, offshore wind turbines have received much more attention, owing to their capabilities for capturing larger wind power compared with on-shore wind turbines. Offshore wind turbines are classified into fixed-foundation offshore wind turbines and floating offshore wind turbines. Floating offshore wind turbines can be installed in deep water over 50 m, which can harvest more and steadier wind power, and have less environment effect. As a result, floating offshore wind turbines will be being invested more and more, and would dominate wind turbine industries in the future. Due to the limited accessibility and a more complex structure integrated with wind turbine machine, mooring lines and floating platform, it is challenging but promising to further stimulate the research and development of real-time monitoring and fault diagnosis, prognosis and remaining useful life prediction, and resilient control for floating off-shore wind turbines to improve the reliability, availability, and productiveness.

In addition, wireless sensory and distributed networked wind farms would bring new opportunities and challenges for reliability and safety of wind turbine systems. Diagnosis and resilient control against cyber-attacks in wind turbine systems would be a promising research topic in the near future.

We have tried to comprise as many up-to-date references for fault diagnosis, prognosis, and resilient control for wind turbines as possible. Woefully, it is impossible to include all the existing publications due to the limit of space. We hope this review paper can bring a light to the researchers and engineers so that they can get insight into this field conveniently.

Author Contributions: Conceptualization, Z.G.; writing—original draft preparation, X.L., Z.G.; writing—revision, Z.G.; supervision, Z.G.; project administration, Z.G.; All authors have read and agreed to the published version of the manuscript.

Funding: This research was funded by the National Nature Science Foundation of China, grant number 61673074; Guangdong Basic and Applied Basic Research Foundation, grant number 1515110234; and Nature Science Foundation of Top Talent of SZTU, grant number 2020106.

Acknowledgments: The authors would like to acknowledge the research support from Northumbria University (UK), and the National Nature Science Foundation of China under the grant 61673074.

Conflicts of Interest: The authors declare no conflict of interest.

References

- Verbruggen, T. Wind turbine operation & maintenance based on condition monitoring. In *ECN Wind Energy*; Technical Report ECN-C-03-047; ECN: Petten, The Netherlands, 2003.
- McMillan, D.; Ault, G. Quantification of condition monitoring benefit for offshore wind turbines. *Wind Energy* **2007**, *31*, 267–285. [[CrossRef](#)]
- Drewry, M.; Georgiou, G. A review of NDT techniques for wind turbines. *Insight* **2007**, *49*, 137–141. [[CrossRef](#)]
- Amirat, Y.; Benbouzid, M.; Al-Ahmar, E.; Bensaker, B.; Turri, S. A brief status on condition monitoring and fault diagnosis in wind energy conversion systems. *Renew. Sustain. Energy Rev.* **2009**, *13*, 2629–2636. [[CrossRef](#)]
- Aval, S.; Ahadi, A. Wind turbine fault diagnosis techniques and related algorithms. *Int. J. Renew. Energy Res.* **2016**, *6*, 80–89.
- Hameed, Z.; Hong, Y.; Cho, Y.; Ahn, S.; Song, C. Condition monitoring and fault detection of wind turbines and related algorithms: A review. *Renew. Sustain. Energy Rev.* **2009**, *13*, 1–39. [[CrossRef](#)]
- Lu, B.; Li, Y.; Wu, X.; Yang, Z. A review of recent advances in wind turbine condition monitoring and fault diagnosis. In *Proceedings of the IEEE Power Electronics and Machines in Wind Applications*, Lincoln, NE, USA, 24–26 June 2009; pp. 1–7.
- Márquez, F.; Tobias, A.; Pérez, J.; Papaalias, M. Condition monitoring of wind turbines: Techniques and methods. *Renew. Energy* **2012**, *46*, 169–178. [[CrossRef](#)]
- Sharma, S.; Mahto, D. Condition monitoring of wind turbines: A review. *Int. J. Sci. Eng. Res.* **2013**, *4*, 35–50.
- Tchakoua, P.; Wamkeue, R.; Ouebec, M.; Slaoui-Hasnaoui, F.; Tameghe, T.; Ekemb, G. Wind turbine condition monitoring: State-of-the-art review, new trends, and future challenges. *Energies* **2014**, *7*, 2595–2630. [[CrossRef](#)]
- Liu, W.; Tang, B.; Han, J.; Lu, X.; He, Z. The structure healthy condition monitoring and fault diagnosis methods in wind turbines: A review. *Renew. Sustain. Energy Rev.* **2015**, *44*, 466–472. [[CrossRef](#)]
- Lian, J.; Cai, O.; Dong, X.; Jiang, Q.; Zhao, Y. Health monitoring and safety evaluation of the offshore wind turbine structure: A review and discussion of future development. *Sustainability* **2019**, *11*, 494. [[CrossRef](#)]
- Hart, E.; Clarker, B.; Nicholas, G.; Amiri, A.; Stirling, J.; Carroll, J.; Dwyer-Joyce, R.; McDonald, A.; Long, H. A review of wind turbine main bearings: Design, operation, modelling, damage mechanisms and fault detection. *Wind Energy Sci.* **2020**, *5*, 105–204. [[CrossRef](#)]
- Qiao, W.; Lu, D. A survey on wind turbine condition monitoring and fault diagnosis-part I: Components and subsystems. *IEEE Trans. Ind. Electron.* **2015**, *62*, 6536–6545. [[CrossRef](#)]
- Qiao, W.; Lu, D. A survey on wind turbine condition monitoring and fault diagnosis-part II: Signals and signal processing methods. *IEEE Trans. Ind. Electron.* **2015**, *62*, 6546–6557. [[CrossRef](#)]
- Stetco, A.; Dinmohammadi, F.; Zhao, X.; Robu, V.; Flynn, D.; Barnes, M.; Keane, J.; Nenadic, G. Machine learning methods for wind turbine condition monitoring: A review. *Renew. Energy* **2019**, *133*, 620–635. [[CrossRef](#)]
- Huang, S.; Wu, X.; Liu, X.; Gao, J.; He, Y. Overview condition monitoring and operation control of electric power conversion systems in direct-drive wind turbines under faults. *Front Mech. Eng.* **2017**, *12*, 281–302. [[CrossRef](#)]
- Lau, B.; Ma, E.; Pecht, M. Review of offshore wind turbine failures and fault prognostic methods. In *Proceedings of the IEEE Conference on Prognostics and System Health Management (PHM)*, Beijing, China, 23–25 May 2012; pp. 1–5.
- Kandukuri, S.; Klausen, A.; Karimi, H.; Robbersmyr, K. A review of diagnostics and prognostics of low-speed machinery towards wind turbine farm-level health management. *Renew. Sustain. Energy Rev.* **2016**, *53*, 697–708. [[CrossRef](#)]
- Leite, G.; Araujo, A.; Rosas, P. Prognostic techniques applied to maintenance of wind turbines: A concise and specific review. *Renew. Sustain. Energy Rev.* **2018**, *81*, 1917–1925. [[CrossRef](#)]

21. Abid, K.; Mouchaweh, M.; Cornez, L. Fault prognosis for the predictive maintenance of wind turbines: State of the art. In Proceedings of the Joint European Conference on Machine Learning and Knowledge Discovery in Databases, Dublin, Ireland, 10–14 September 2018; pp. 113–125.
22. Pourmohammad, S.; Fekih, A. Fault-tolerant control of wind turbine systems—a review. In Proceedings of the IEEE Green Technologies Conference, Baton Rouge, LA, USA, 21 April 2011; pp. 1–6.
23. Gao, Z.; Sheng, S. Real-time monitoring, prognosis, and resilient control for wind turbine systems. *Renew. Energy* **2018**, *116*, 1–4. [[CrossRef](#)]
24. Schrick, D. Remarks on terminology in the field of supervision, fault detection and diagnosis. In Proceedings of the IFAC Symposium on Fault Detection, Supervision Safety for Technical Processes, Hull, UK, 26–28 August 1997; pp. 959–964.
25. Gao, Z.; Cecati, C.; Ding, S. A Survey of fault diagnosis and fault-tolerant techniques part I: Fault diagnosis with model- and signal-based approaches. *IEEE Trans. Ind. Electron.* **2015**, *62*, 3575–3767. [[CrossRef](#)]
26. Hahn, B.; Durstewitz, M.; Rohrig, K. Reliability of Wind Turbines. *Wind Energy Eng.* **2007**, 329–332.
27. Anderson, P.; Bose, A. Stability simulation of wind turbine systems. *IEEE Trans. Power Syst.* **1983**, *102*, 3791–3795. [[CrossRef](#)]
28. Ekanayake, J.; Holdsworth, L.; Wu, X.; Jenkins, N. Dynamic modelling of doubly fed induction generator wind turbines. *IEEE Trans. Power Syst.* **2003**, *18*, 803–809. [[CrossRef](#)]
29. Kim, S.; Kim, E. PSCAD/EMTDC-based modelling and analysis of a gearless variable speed wind turbine. *IEEE Trans. Energy Convers.* **2007**, *22*, 421–430. [[CrossRef](#)]
30. Odgaard, P.; Stoustrup, J.; Kinnaert, M. Fault tolerant control of wind turbines—A benchmark model. In Proceedings of the 7th IFAC Symposium on Fault Detection, Supervision and Safety of Technical Processes, Barcelona, Spain, 30 June–3 July 2009; pp. 155–160.
31. Odgaard, P.; Stoustrup, J.; Kinnaert, M. Fault-tolerant control of wind turbines: A benchmark model. *IEEE Trans. Control Syst. Technol.* **2013**, *21*, 1168–1182. [[CrossRef](#)]
32. Odgaard, P.; Johnson, K. Wind turbine fault detection and fault tolerant control—an enhanced benchmark challenge. In Proceedings of the American Control Conference, Washington, DC, USA, 17–19 June 2013; pp. 4447–4452.
33. Zhu, Y.; Gao, Z. Robust observer-based fault detection via evolutionary optimization with applications to wind turbine systems. In Proceedings of the IEEE 9th Conference on Industrial Electronics and Applications (ICIEA), Hangzhou, China, 9–11 June 2014; pp. 1627–1632.
34. Jlassi, I.; Estima, J.; Khil, S.; Bellaaj, N.; Cardoso, A. Multiple open-circuit faults diagnosis in back-to-back converters of PMSG drives for wind turbine systems. *IEEE Trans. Power Electron.* **2015**, *30*, 2689–2702. [[CrossRef](#)]
35. Simani, S.; Farsoni, S.; Castaldi, P. Fault diagnosis of a wind turbine benchmark via identified fuzzy models. *IEEE Trans. Ind. Electron.* **2015**, *62*, 3775–3782. [[CrossRef](#)]
36. Liu, X.; Gao, Z.; Chen, M. Takagi-Sugeno fuzzy model based fault estimation and signal compensation with application to wind turbines. *IEEE Trans. Ind. Electron.* **2017**, *64*, 5678–5689. [[CrossRef](#)]
37. Shao, H.; Gao, Z.; Liu, X.; Busawon, K. Parameter-varying modelling and fault reconstruction for wind turbine systems. *Renew. Energy* **2018**, *116*, 145–152. [[CrossRef](#)]
38. Sanchez, H.; Escobet, T.; Puig, V.; Odgaard, P. Fault diagnosis of an advanced wind turbine benchmark using interval-based ARR and observers. *IEEE Trans. Ind. Electron.* **2015**, *62*, 3783–3793. [[CrossRef](#)]
39. Kalman, R. A new approach to linear filtering and prediction problems. *J. Basic Eng.* **1960**, *82*, 35–45. [[CrossRef](#)]
40. Wei, X.; Verhaegen, M.; Engelen, T. Sensor fault detection and isolation for wind turbines based on subspace identification and Kalman filter techniques. *Int. J. Adapt. Control Signal Process.* **2010**, *24*, 687–707. [[CrossRef](#)]
41. Dey, S.; Pisu, P.; Ayalew, B. A comparative study of three fault diagnosis schemes for wind turbines. *IEEE Trans. Control Syst. Technol.* **2015**, *23*, 1853–1868. [[CrossRef](#)]
42. Cao, M.; Qiu, Y.; Feng, Y.; Wang, H.; Li, D. Study of wind turbine fault diagnosis based on unscented Kalman filter and SCADA data. *Energies* **2016**, *9*, 847. [[CrossRef](#)]
43. Wu, X.; Li, Y.; Li, F.; Yang, Z.; Teng, W. Adaptive estimation-based leakage detection for a wind turbine hydraulic pitching system. *IEEE Trans. Mechatron.* **2012**, *17*, 907–914. [[CrossRef](#)]
44. Guo, P.; Infield, D.; Yang, X. Wind turbine generator condition monitoring using temperature trend analysis. *IEEE Trans. Sustain. Energy* **2012**, *3*, 124–133. [[CrossRef](#)]
45. Freire, N.; Estima, J.; Cardoso, A. Open-circuit fault diagnosis in PMSG drives for wind turbine applications. *IEEE Trans. Ind. Electron.* **2013**, *60*, 3957–3967. [[CrossRef](#)]
46. Tamilselvan, P.; Wang, P.; Sheng, S.; Twomey, J. A two-stage diagnosis frame work for wind turbine gearbox condition monitoring. *Int. J. Progn. Health Manag.* **2013**, *4*, 21–31.
47. Zappalá, D.; Tavner, P.; Crabtree, C.; Sheng, S. Side-band algorithm for automatic wind turbine gearbox fault detection and diagnosis. *IET Renew. Power Gener.* **2014**, *8*, 380–389. [[CrossRef](#)]
48. Yang, W.; Tavner, P.; Wilkinson, M. Condition monitoring and fault diagnosis of a wind turbine synchronous generator drive train. *IET Renew. Power Gener.* **2009**, *3*, 1–11. [[CrossRef](#)]
49. Watson, S.; Xiang, B.; Yang, W.; Tavner, P.; Crabtree, C. Condition monitoring of the power output of wind turbine generators using wavelets. *IEEE Trans. Energy Convers.* **2010**, *25*, 715–721. [[CrossRef](#)]

50. Yang, W.; Tavner, P.; Crabtree, C.; Wilkinson, M. Cost-effective condition monitoring for wind turbines. *IEEE Trans. Ind. Electron.* **2010**, *57*, 263–271. [[CrossRef](#)]
51. Teng, W.; Wang, F.; Zhang, K.; Liu, Y.; Ding, X. Pitting fault detection of a wind turbine gearbox using empirical mode decomposition. *J. Mech. Eng.* **2014**, *60*, 12–20. [[CrossRef](#)]
52. Yoon, J.; He, D.; Hecke, B. On the use of a single piezoelectric strain sensor for wind turbine planetary gearbox fault diagnosis. *IEEE Trans. Ind. Electron.* **2015**, *62*, 6585–6593. [[CrossRef](#)]
53. Tang, B.; Liu, W.; Song, T. Wind turbine fault diagnosis based on Morlet wavelet transformation and Wigner-Ville distribution. *Renew. Energy* **2010**, *35*, 2822–2866. [[CrossRef](#)]
54. Barszcz, T.; Randall, R. Application of spectral kurtosis for detection of a tooth crack in the planetary gear of a wind turbine. *Mech. Syst. Signal Process* **2009**, *23*, 1352–1365. [[CrossRef](#)]
55. Chen, J.; Pan, J.; Li, Z.; Zi, Y.; Chen, X. Generator bearing fault diagnosis via empirical wavelet transform using measured vibration signals. *Renew. Energy* **2016**, *89*, 80–92. [[CrossRef](#)]
56. Kum, S.; Sahin, B. A root cause analysis for arctic marine accidents from 1993 to 2011. *Saf. Sci.* **2015**, *74*, 206–220. [[CrossRef](#)]
57. Unver, B.; Gurgun, S.; Sahin, B.; Altin, I. Crankcase explosion for two-stroke marine diesel engine by using fault tree analysis method in fuzzy environment. *Eng. Fail. Anal.* **2019**, *97*, 288–299. [[CrossRef](#)]
58. Shafiee, M.; Dinmohammadi, F. An FMEA-based risk assessment approach for wind turbine systems: A comparative study of onshore and offshore. *Energies* **2014**, *7*, 619–642. [[CrossRef](#)]
59. Dinmohammadi, F.; Shafiee, M. A fuzzy FEMA-based risk assessment approach for offshore wind turbines. *Int. J. Progn. Health Manag.* **2013**, *4*, 1–10.
60. Yang, Z.; Wang, B.; Dong, X.; Liu, H. Expert system of fault diagnosis for gear box in wind turbine. *Syst. Eng. Procedia* **2012**, *4*, 189–195.
61. Garcia, M.; Sanz-Bobi, M.; Pico, J. SIMAP: Intelligent system for predictive maintenance: Application to the health condition monitoring of a wind turbine gearbox. *Comput. Ind.* **2006**, *57*, 552–568. [[CrossRef](#)]
62. Pozo, F.; Vidal, Y. Wind turbine fault detection through principal component analysis and statistical hypothesis testing. *Energies* **2016**, *9*, 3. [[CrossRef](#)]
63. Wang, J.; Gao, R.; Yan, R. Integration of EEMD and ICA for wind turbine gearbox diagnosis. *Wind Energy* **2014**, *7*, 757–773. [[CrossRef](#)]
64. Ding, S.; Zhang, P.; Naik, A.; Ding, E.; Huang, B. Subspace method aided data-driven design of fault detection and isolation systems. *J. Process Control* **2009**, *19*, 1496–1510. [[CrossRef](#)]
65. Lou, J.; Lu, H.; Xu, J.; Qu, Z. A data-mining approach for wind turbine power generation performance monitoring based on power curve. *Int. J. Smart Home* **2016**, *10*, 137–152. [[CrossRef](#)]
66. Yampikulsakul, N.; Byon, E.; Huang, S.; Sheng, S.; You, M. Condition monitoring of wind power system with nonparametric regression analysis. *IEEE Trans. Energy Convers.* **2014**, *29*, 288–299.
67. Santos, P.; Villa, L.; Reñones, A.; Bustillo, A.; Maudes, J. An SVM-based solution for fault detection in wind turbines. *Sensors* **2015**, *15*, 5627–5648. [[CrossRef](#)]
68. Schlechtingen, M.; Santos, I. Comparative analysis of neural network and regression based condition monitoring approaches for wind turbine fault detection. *Mech. Syst. Signal Process.* **2011**, *25*, 1849–1875. [[CrossRef](#)]
69. Xiang, J.; Watson, S.; Liu, Y. Smart monitoring of wind turbines using neural networks. In *Sustainability in Energy and Buildings*; Springer: Berlin/Heidelberg, Germany, 2009; pp. 1–8.
70. Üstüntaş, T.; Şahin, A. Wind turbine power curve estimation based on cluster center fuzzy logic modeling. *J. Wind Eng. Ind. Aerodyn.* **2008**, *96*, 611–620. [[CrossRef](#)]
71. Teng, W.; Cheng, H.; Ding, X.; Liu, Y.; Ma, Z.; Mu, H. DNN based method for fault detection in a direct drive wind turbine. *IET Renew. Energy Gener.* **2018**, *12*, 1164–1171. [[CrossRef](#)]
72. Yang, Z.; Wang, X.; Zhong, J. Representational learning for fault diagnosis of wind turbine equipment: A multi-layered extreme learning machines approach. *Energies* **2016**, *9*, 379. [[CrossRef](#)]
73. Schlechtingen, M.; Santos, I.; Achiche, S. Wind turbine condition monitoring based on SCADA data using normal behaviour models. Part 1: System description. *Appl. Soft Comput.* **2013**, *13*, 259–270. [[CrossRef](#)]
74. Kusiak, A.; Zheng, H.; Song, Z. Models for monitoring wind farm power. *Renew. Energy* **2009**, *34*, 583–590. [[CrossRef](#)]
75. Odofin, S.; Gao, Z.; Sun, K. Robust fault estimation in wind turbine systems using GA optimization. In Proceedings of the 13rd IEEE Conferences on Industrial Informatics, Cambridge, UK, 22–24 June 2015; pp. 580–585.
76. Rahimilarki, R.; Gao, Z.; Zhang, A.; Binns, R. Robust neural network fault estimation approach for nonlinear dynamic systems with applications to wind turbine systems. *IEEE Trans. Ind. Inform.* **2019**, *15*, 6302–6312. [[CrossRef](#)]
77. Fernandes-Canti, R.; Blesa, J.; Tornil-Sin, S.; Puig, V. Fault detection and isolation for a wind turbine benchmark using a mixed Bayesian/set-membership approach. *Annu. Rev. Control* **2015**, *40*, 59–69. [[CrossRef](#)]
78. Liu, W.; Wang, Z.; Han, J.; Wang, G. Wind turbine fault diagnosis method based on diagonal spectrum and clustering binary tree SVM. *Renew. Energy* **2013**, *50*, 1–6.
79. Fu, Y.; Gao, Z.; Liu, Y.; Zhang, A.; Yin, X. Actuator and sensor fault classification for wind turbine systems based on fast Fourier transform and uncorrelated multi-linear principal component analysis techniques. *Processes* **2020**, *8*, 1066. [[CrossRef](#)]

80. Konga, C.; Kima, T.; Hanb, D.; Sugiyamac, Y. Investigation of fatigue life for a medium scale composite wind turbine blade. *Int. J. Fatigue* **2006**, *28*, 1382–1388. [[CrossRef](#)]
81. Epaarachchi, J.; Clausen, P. The development of a fatigue loading spectrum for small wind turbine blades. *J. Wind Eng. Ind. Aerodyn.* **2006**, *94*, 207–223. [[CrossRef](#)]
82. Cárdenas, D.; Elizalde, H.; Marzocca, P.; Gallegos, S.; Probst, O. A coupled aeroelastic damage progression model for wind turbine blades. *Compos. Struct.* **2012**, *94*, 3072–3081. [[CrossRef](#)]
83. Hosseini-Toudeshky, H.; Jahanmardi, M.; Goodarzi, M. Progressive debonding analysis of composite blade root joint of wind turbines under fatigue loading. *Compos. Struct.* **2015**, *120*, 417–427. [[CrossRef](#)]
84. Wang, P.; Tamilselvan, P.; Twomey, J.; Youn, B. Prognosis-informed wind farm operation and maintenance for concurrent economic and environmental benefits. *Int. J. Precis. Eng. Manuf.* **2013**, *14*, 1049–1056. [[CrossRef](#)]
85. Chen, B.; Matthews, P.; Tavner, P. Wind turbine pitch faults prognosis using a-priori knowledge-based ANFIS. *Expert Syst. Appl.* **2013**, *40*, 6863–6876. [[CrossRef](#)]
86. Chen, B.; Matthews, P.; Tavner, P. Automated on-line fault prognosis for wind turbine pitch systems using supervisory control and data acquisition. *IET Renew. Power Gener.* **2015**, *9*, 503–513. [[CrossRef](#)]
87. Kusiak, A.; Verma, A. A data-driven approach for monitoring blade pitch faults in wind turbines. *IEEE Trans. Sustain. Energy* **2011**, *2*, 87–96. [[CrossRef](#)]
88. Kusiak, A.; Li, W. The prediction and diagnosis of wind turbine faults. *Renew. Energy* **2011**, *36*, 16–23. [[CrossRef](#)]
89. Zhu, J.; Yoon, J.; He, D.; Bechhoefer, E. Online particle contaminated lubrication oil condition monitoring and remaining useful life prediction for wind turbines. *Wind Energy* **2015**, *18*, 1131–1149. [[CrossRef](#)]
90. Acho, L.; Rodellar, J.; Tutiven, C.; Vidal, Y. Passive fault tolerant control strategy in controlled wind turbines. In Proceedings of the Conference on Control and Fault-Tolerant Systems, Barcelona, Spain, 7–9 September 2016; pp. 636–641.
91. Sloth, C.; Esbensen, T.; Stoustrup, T. Active and passive fault-tolerant LPV control of wind turbines. In Proceedings of the American Control Conference, Baltimore, MD, USA, 30 June–2 July 2010; pp. 4640–4646.
92. Badihi, H.; Zhang, Y. Passive fault-tolerant cooperative control in an offshore wind farm. *Energy Procedia* **2017**, *105*, 2959–2964. [[CrossRef](#)]
93. Rodellar, J.; Tutiven, C.; Acho, L.; Vidal, Y. Fault tolerant control design of floating offshore wind turbines. In Proceedings of the European Conference on Structural Control, Sheffield, UK, 11–13 July 2016; p. 160.
94. Gao, R.; Gao, Z. Pitch control for wind turbine systems using optimization, estimation and compensation. *Renew. Energy* **2016**, *91*, 501–515. [[CrossRef](#)]
95. Vidal, Y.; Tutivén, C.; Rodellar, J.; Acho, L. Fault diagnosis and fault tolerant control of wind turbines via a discrete time controller with disturbance compensator. *Energies* **2015**, *8*, 4300–4316. [[CrossRef](#)]
96. Lan, J.; Patton, R.; Zhu, X. Fault-tolerant wind turbine pitch control using adaptive sliding mode estimation. *Renew. Energy* **2018**, *116*, 219–231. [[CrossRef](#)]
97. Chen, J.; Jiang, L.; Yao, W.; Wu, Q. Perturbation estimation based nonlinear adaptive control of a full-rated converter wind turbine for fault ride-through capability enhancement. *IEEE Trans. Power Syst.* **2014**, *29*, 2733–2743. [[CrossRef](#)]
98. Azizi, A.; Nourisolaa, S.; Shoja-Majidabad, S. Fault tolerant control of wind turbines with an adaptive output feedback sliding mode controller. *Renew. Energy* **2019**, *135*, 55–56. [[CrossRef](#)]
99. Maati, Y.; Bahir, L. Optimal fault tolerant control of large-scale wind turbines in the case of the pitch actuator partial faults. *Complexity* **2020**. [[CrossRef](#)]
100. Jain, T.; Yame, J. Health-aware fault-tolerant receding horizon control of wind turbines. *Control Eng. Pract.* **2020**, *95*. [[CrossRef](#)]
101. Kanjiya, P.; Ambati, B.; Khadkikar, V. A novel fault-tolerant DFIG-based wind energy conversion system for seamless operation during grid faults. *IEEE Trans. Power Syst.* **2014**, *29*, 1296–1305. [[CrossRef](#)]
102. Shahbazi, M.; Poure, P.; Saadate, S. Real-time power switch fault diagnosis and fault-tolerant operation in a DFIG-based wind energy system. *Renew. Energy* **2018**, *116*, 209–218. [[CrossRef](#)]
103. Bolbolnia, R.; Heydari, E.; Abbaszadeh, K. Fault tolerant control in direct-drive PMSG wind turbine systems under open circuit faults. In Proceedings of the 11th Power Electronics, Drive Systems, and Technologies Conference, Tehran, Iran, 4–6 February 2020. [[CrossRef](#)]
104. Wang, G.; Huang, Z. Data-driven fault-tolerant control design for wind turbines with robust residual generator. *IET Control Theory Appl.* **2015**, *9*, 1173–1179. [[CrossRef](#)]
105. Luo, H.; Ding, S.; Haghani, A.; Hao, H.; Yin, S.; Jeinsch, T. Data-driven design of KPI-related fault-tolerant control system for wind turbines. In Proceedings of the American Control Conference, Washington, DC, USA, 17–19 June 2013; pp. 4465–4470.
106. Liu, Y.; Frederik, J.; Ferrari, R.; Wu, P.; Li, S.; Wingerden, J. Adaptive fault accommodation of pitch actuator stuck type of fault in floating offshore wind turbines: A subspace predictive repetitive control approach. In Proceedings of the American Control Conference, Denver, CO, USA, 1–3 July 2020; pp. 4077–4082.