

Fault Diagnosis of the Blocking Diesel Particulate Filter Based on Spectral Analysis

Authors:

Shuang-xi Liu, Ming Lü

Date Submitted: 2020-01-20

Keywords: spectral analysis, exhaust pressure, fault diagnosis, blockage, DPF

Abstract:

Diesel particulate filter is one of the most effective after-treatment techniques to reduce Particulate Matters (PM) emissions from a diesel engine, but the blocking Diesel Particulate Filter (DPF) will seriously affect the engine performance, so it is necessary to study the fault diagnosis of blocking DPF. In this paper, a simulation model of an R425DOHC diesel engine with wall-flow ceramic DPF was established, and then the model was verified with experimental data. On this basis, the fault diagnosis of the blocking DPF was studied by using spectral analysis on instantaneous exhaust pressure. The results showed that both the pre-DPF mean exhaust pressure and the characteristic frequency amplitude of instantaneous exhaust pressure can be used as characteristic parameters of monitoring the blockage fault of DPF, but it is difficult to monitor DPF blockage directly by instantaneous exhaust pressure. In terms of sensitivity, the characteristic frequency amplitude of instantaneous exhaust pressure is more suitable as a characteristic parameter to monitor DPF blockage than mean exhaust pressure. This work can lay an important theoretical foundation for the on-board diagnosis of DPF.

Record Type: Published Article

Submitted To: LAPSE (Living Archive for Process Systems Engineering)

Citation (overall record, always the latest version):

LAPSE:2020.0084

Citation (this specific file, latest version):

LAPSE:2020.0084-1

Citation (this specific file, this version):

LAPSE:2020.0084-1v1

DOI of Published Version: <https://doi.org/10.3390/pr7120943>

License: Creative Commons Attribution 4.0 International (CC BY 4.0)

Article

Fault Diagnosis of the Blocking Diesel Particulate Filter Based on Spectral Analysis

Shuang-xi Liu ¹ and Ming Lü ^{2,*}

¹ National Engineering Laboratory for Mobile Source Emission Control Technology, China Automotive Technology & Research Center, Tianjin 300300, China; liushuangxi1970@126.com

² School of Mechanical, Electronic and Control Engineering, Beijing Jiaotong University, Beijing 100044, China

* Correspondence: lvming@bjtu.edu.cn

Received: 23 October 2019; Accepted: 3 December 2019; Published: 10 December 2019



Abstract: Diesel particulate filter is one of the most effective after-treatment techniques to reduce Particulate Matters (PM) emissions from a diesel engine, but the blocking Diesel Particulate Filter (DPF) will seriously affect the engine performance, so it is necessary to study the fault diagnosis of blocking DPF. In this paper, a simulation model of an R425DOHC diesel engine with wall-flow ceramic DPF was established, and then the model was verified with experimental data. On this basis, the fault diagnosis of the blocking DPF was studied by using spectral analysis on instantaneous exhaust pressure. The results showed that both the pre-DPF mean exhaust pressure and the characteristic frequency amplitude of instantaneous exhaust pressure can be used as characteristic parameters of monitoring the blockage fault of DPF, but it is difficult to monitor DPF blockage directly by instantaneous exhaust pressure. In terms of sensitivity, the characteristic frequency amplitude of instantaneous exhaust pressure is more suitable as a characteristic parameter to monitor DPF blockage than mean exhaust pressure. This work can lay an important theoretical foundation for the on-board diagnosis of DPF.

Keywords: DPF; blockage; fault diagnosis; exhaust pressure; spectral analysis

1. Introduction

With the development of the economy and the progress of science and technology, the automatic industry has developed rapidly. Diesel engines have been widely used because of their good power, economy, reliability, and emission (lower CO and HC compared with gasoline engines) performances. Not only do diesel engines hold the dominant position in the area of medium- and heavy-duty vehicles, but they are also applied widely in light-duty vehicles in the present situation [1]. While the automobile brings convenience to human life, the related pollution problem is becoming more and more serious. Therefore, many countries have established more and more rigorous regulations to limit engine emissions. In order to reduce the emission pollutants of diesel engines, the researchers have taken many measures, such as improving fuel quality, internal purification technology, and after-treatment technology. For the moment, to satisfy the increasingly stringent emission regulations, we must depend on both internal purification technology and after-treatment technology.

The diesel particulate filter (DPF) is one of the most effective after-treatment techniques to reduce PM emissions from the diesel engine, which has been widely used [2]. At present, the wall flow filter invented by America Corning Company is regarded as the best filter because of its performance and its micro structure [3].

DPFs have been used in diesel engine vehicles for over 10 years [4–9], since the French Peugeot Company invented the DPF system in 2000. During the use of DPF, with the increase in particulate depositions in the DPF, the exhaust resistance of the diesel engine increases, and blocking the DPF will

seriously affect the engine performance (particulate depositions increase to a certain extent). To avoid the blockage fault of DPFs and to satisfy the increasingly stringent emission regulations, we need to monitor and diagnose the blockage situation of DPFs so as to clean particulates at the proper time. Therefore, it is necessary to study the fault diagnosis of blocking DPFs.

In recent years, many researchers [10–15] have carried out a lot of research on the fault diagnosis of blocking DPFs. At present, the most common used fault diagnosis method is to monitor the average exhaust pressure pre-DPF [2], but the exhaust pressure is changing constantly, as for on board diagnosis, the method has some disadvantages in sensitivity and aging characteristics. As a result, some researchers want to apply a new method to studying the fault diagnosis of blocking DPFs. Kumar et al. [16] raised a fault diagnosis method based on power spectral density theory, to diagnose the failure status of DPFs by analyzing the power spectral density of upstream and downstream sensor waveforms. Surve et al. [5] conducted the fault diagnosis of DPFs by combining the correlation analysis method with the spectral analysis method—the principle is to diagnose the failure status of DPF by calculating the characteristic value of the transfer function, and the advantages include that the failure status of the DPF can be diagnosed under the transient conditions of the diesel engine and that the slight failure of the DPF can also be found. Gupta et al. [17] raised a new fault diagnosis method based on the adaptive model. This method has great robustness for modeling error, sensor noise, and process variability, and it can be applied to on-board diagnosis (OBD) without any extra sensors.

To our knowledge, although some researchers have conducted a lot of research on the fault diagnosis of blocking DPFs and obtained many research results, there is still no consensus over how to efficiently monitor and diagnose the DPF system (and reach the level of OBD). Also, the methods to monitor and diagnose DPF status are still not comprehensive. Therefore, the spectral analysis method is applied in this paper to study the fault diagnosis of blocking DPF. This work can lay an important theoretical foundation for the on board diagnosis of DPF.

In this paper, a simulation model of a R425DOHC diesel engine with wall-flow ceramic DPF was established, and then the model was verified. On this basis, the effects of different blockage extents on the mean exhaust pressure of pre-DPF and the effects of different blockage extents on instantaneous exhaust pressure and its frequency spectrum were studied, and the sensitivity of mean exhaust pressure and characteristic frequency amplitude of instantaneous exhaust pressure with an increase in particulate depositions in DPF were comparatively studied.

2. Simulation Model and Validation

The research object was an R425DOHC diesel engine with a wall-flow ceramic DPF, and its main technical parameters are shown in Tables 1 and 2. GT-SUITE software was applied in this paper, which can be used for the performance simulation of an engine and after-treatment system. On this basis, a simulation model of the R425DOHC diesel engine with wall-flow ceramic DPF was established, as shown in Figure 1.

Table 1. Main parameters of the R425DOHC diesel engine.

Diesel Parameters	Value	Diesel Parameters	Value
Rated speed (r/min)	4000	Rated power (kW)	105
Max torque (N·m)	340	Displacement (L)	2.499
Bore × Stroke (mm)	92 × 94	Cylinder number	4
Compression ratio	17.5:1	Stroke	4

Table 2. Main parameters of the diesel particulate filter.

DPF Parameters	Value
Filter length (mm)	200
Filter diameter (mm)	190
Cell density (cm^{-2})	16

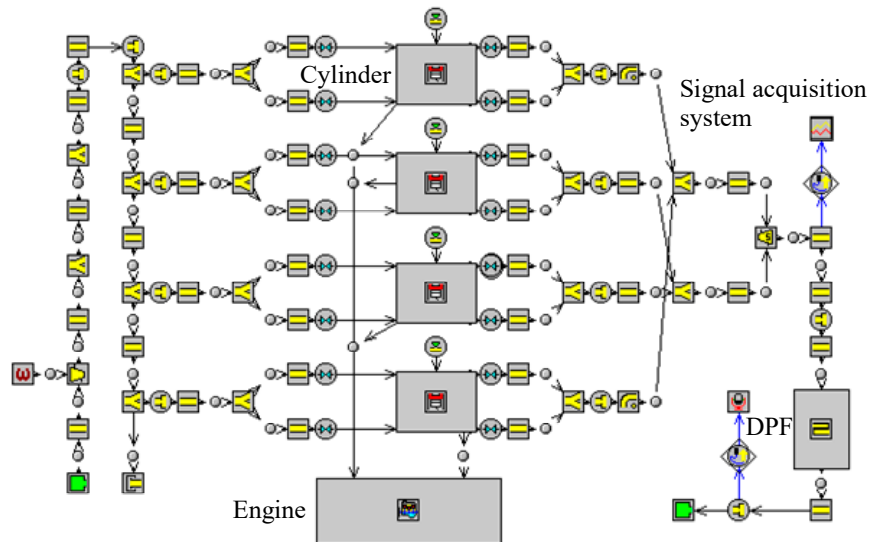
**Figure 1.** GT-Power model of an R425DOHC diesel engine with a diesel particulate filter (DPF).

To verify the accuracy of simulation model, we compared the simulation results of power performance and fuel economy under external characteristics with experimental data of the diesel engine, and the compared results are shown in Figures 2 and 3 and Table 3. In Figures 2 and 3, we set engine load as full-load, and set engine speed as 1000 r/min, 1500 r/min, 2000 r/min, 2500 r/min, 3000 r/min, 3500 r/min, and 4000 r/min. In Table 3, the max torque point was 100% load, 2000 r/min, and the max power point was 100% load, 4000 r/min. In addition, the experimental data of the diesel engine were supplied by the manufacturer.

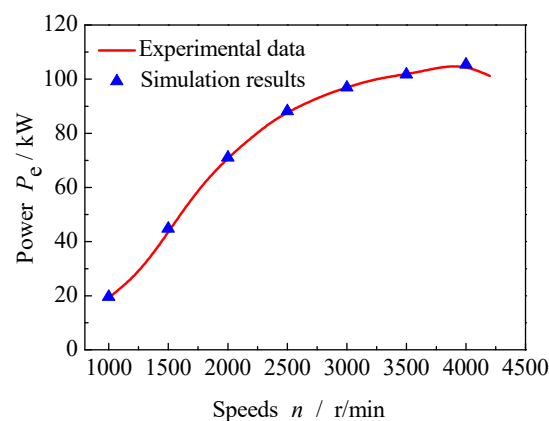
**Figure 2.** Comparison of experimental engine power with simulation results under full-load conditions.

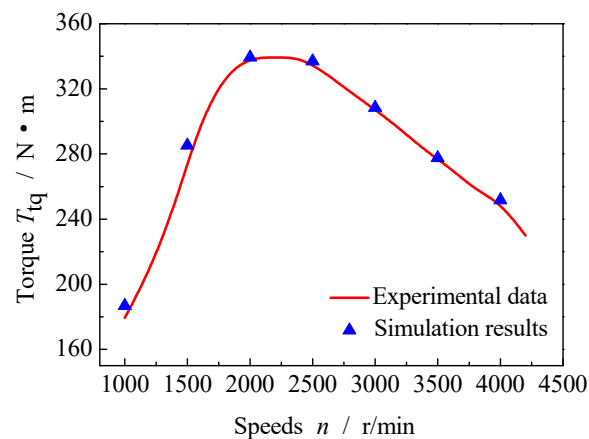

Figure 3. Comparison of experimental engine torque with simulation results under full-load conditions.

Table 3. Comparison of experimental engine specific fuel consumption with simulation results under rated conditions.

Specific Fuel Consumption	Simulation Results	Experimental Data
Max torque point (g/kW·h)	208.9	215
Max power point (g/kW·h)	252.2	256

As shown in Figures 2 and 3 and Table 3, the simulation results of power performance and fuel economy under external characteristics agreed well with the experimental data of the diesel engine, and the calculation errors were less than 5%, which suggests that the simulation model is correct and can be applied to simulating the exhaust characteristics of the diesel engine.

3. Effects of Different Blockage Extents of DPF on Mean Exhaust Pressure

Particulate deposition amounts in a DPF determine the blockage extent of the DPF. Meanwhile, considering the strong pulsation of exhaust pressure, the effects of different blockage extents on the mean exhaust pressure and the instantaneous exhaust pressure will be studied. In this section, the effects of different particulate deposition amounts on mean exhaust pressure will be discussed firstly.

In this section, we set engine speed as 2000 r/min and 4000 r/min—2000 r/min is the maximum torque speed, while 4000 r/min is the maximum power speed (rated speed).

Figure 4 gives the mean exhaust pressure versus particulate deposition amounts in the DPF (0 g, 20 g, 40 g, 60 g) under different engine conditions.

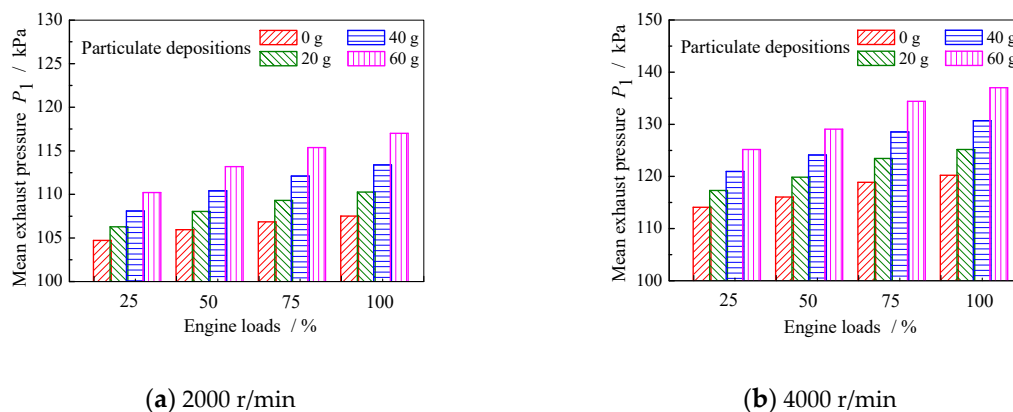

Figure 4. Effects of particulate depositions on the mean exhaust pressure.

As shown in Figure 4, when the engine speed was 2000 r/min or 4000 r/min, under different engine loads, the mean exhaust pressure increased obviously with the increase in particulate depositions in the DPF. This is because particulate depositions affect the circulation performance of the DPF—the more particulate depositions, the worse the circulation performance of the DPF. The exhaust gas cannot be discharged through the DPF to the external environment, which leads to the increase in the mean exhaust pressure pre-DPF.

Also, mean exhaust pressure increased obviously with the increase in diesel engine loads, regardless of the engine speed. In addition, comparing Figure 4a with Figure 4b, under the same engine load, the mean exhaust pressure of pre-DPF when the engine speed was 4000 r/min was greater than that when the engine speed is 2000 r/min. This is because the flow velocity of exhaust gas at high engine speed is higher than that at low engine speed, while the resistance produced by the DPF at flow velocity is greater than that at low flow velocity.

Based on the above analysis, we can determine that monitoring the mean exhaust pressure pre-DPF is a way to understand the situation of particulate depositions in the DPF so that we can diagnose the blockage extent. This conclusion proved again that the commonly used diagnosis method is effective and feasible.

4. Effects of Different Blockage Extents of DPF on the Instantaneous Exhaust Pressure and its Frequency Spectrum

The gas flow in the exhaust system of a diesel engine is an unsteady flow. Exhaust pressure varies not only with engine conditions, but it is also different at different times of one exhaust cycle. So, the blockage extent of a DPF has an effect on the instantaneous exhaust pressure, except for the mean exhaust pressure. In this section, the effects of different blockage extents of DPFs on the instantaneous exhaust pressure will be first studied, then the effects of different blockage extents of DPFs on the frequency spectrum of instantaneous exhaust pressure will be studied, and an attempt will be made to find the eigen value which can be used to diagnose the blockage extents of DPFs.

Similar to the research on mean exhaust pressure, the measurement position of instantaneous exhaust pressure is also at the front of DPFs. Engine load was set as 100%, and engine speeds were set as 1000 r/min, 2000 r/min, 3000 r/min, and 4000 r/min. Particulate deposition amounts in DPF were set as 0 g, 20 g, 40 g, and 60 g, respectively.

Figure 5 shows that the instantaneous exhaust pressure varied with the increase in particulate depositions in DPFs under different engine conditions.

As shown in Figure 5, when engine load was 100%, under different engine speeds, instantaneous exhaust pressure increased with the increase in particulate depositions in the DPF, and the peak and trough values of instantaneous exhaust pressure increased obviously in one exhaust cycle. However, the instantaneous exhaust pressure of a diesel engine varies constantly in the time domain, so it is difficult to diagnose the blockage extents of a DPF by monitoring the instantaneous exhaust pressure in the time domain. Therefore, Fourier transform was applied to process the signal of instantaneous exhaust pressure, and we tried to find the characteristic parameter which can be used to reflect the blockage extents of DPF in frequency domain.

To research whether the frequency amplitude of instantaneous exhaust pressure with different exhaust pulsation frequencies can be used as the characteristic parameter to diagnose the blockage extents of DPF, we need to research the effects of particulate depositions in DPF on the frequency amplitude of instantaneous exhaust pressure with different exhaust pulsation frequencies.

Figure 6 gives the effects of particulate depositions in DPF on the Fourier spectrum of instantaneous exhaust pressure under different engine conditions.

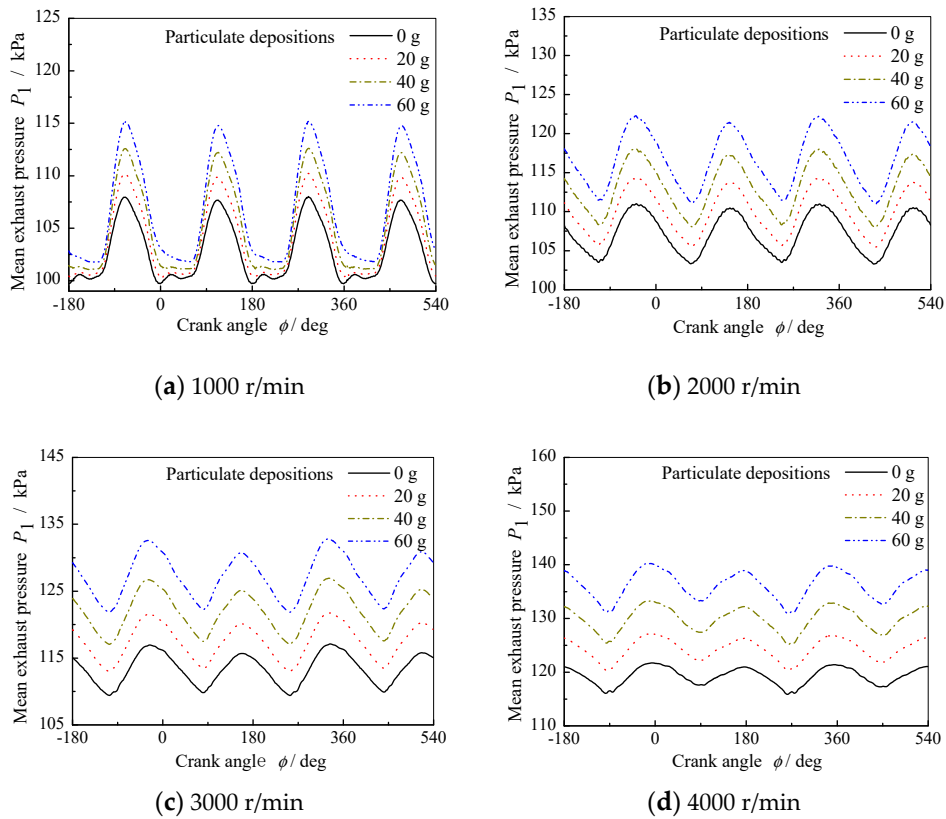

Figure 5. Effects of particulate depositions on the instantaneous exhaust pressure.

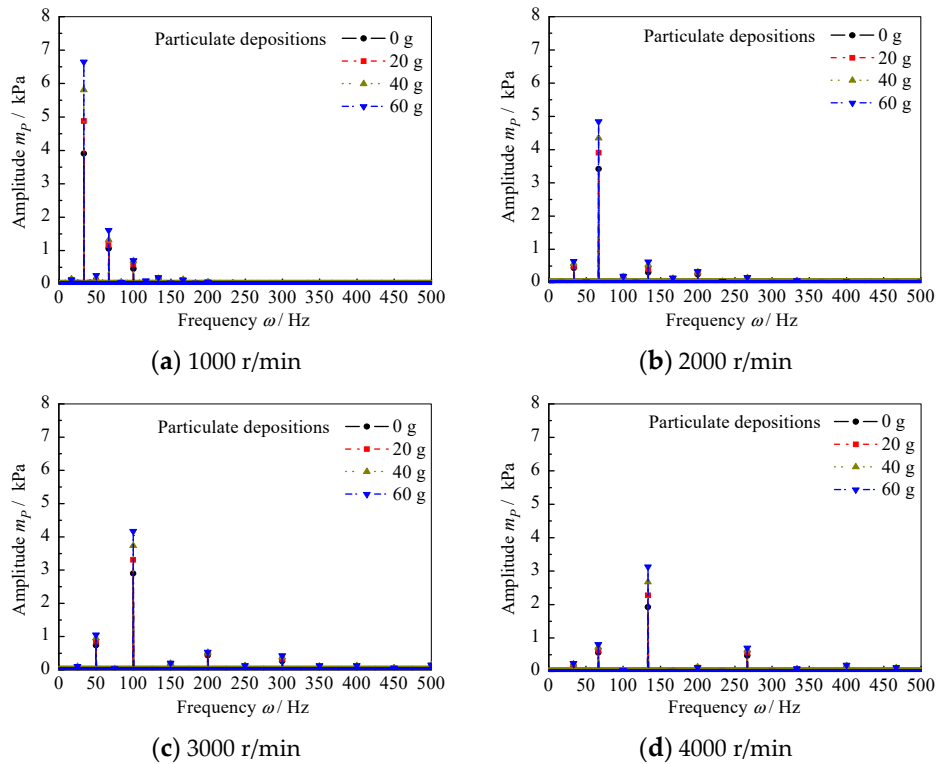

Figure 6. Effects of particulate depositions on the Fourier spectrum of instantaneous exhaust pressure.

As shown in Figure 6, in the Fourier spectrum of instantaneous exhaust pressure, when engine load was 100%, under the same engine speed, although particulate depositions in the DPF were

different, the maximum frequency amplitude corresponded to the same frequency. The frequency is described as the exhaust pulsation frequency of the diesel engine at this speed. In addition, with the increase in particulate depositions in the DPF, the frequency amplitude of instantaneous exhaust pressure with different frequencies increases, and the variation extent of the frequency amplitude under the exhaust pulsation frequency is the most obvious.

In addition, with the increase in engine speeds, the frequency amplitude under the exhaust pulsation frequency decreased gradually. Also, the increasing extent of the frequency amplitude under the exhaust pulsation frequency decreased gradually with the increase in particulate depositions in the DPF. When the engine speed was 1000 r/min, the exhaust pulsation frequency was 33.33 Hz. The frequency amplitudes under the same exhaust pulsation frequency were 3.9 kPa, 4.9 kPa, 5.8 kPa, and 6.6 kPa when particulate depositions in the DPF were 0 g, 20 g, 40 g, and 60 g, respectively. When the engine speed was 3000 r/min, the exhaust pulsation frequency was 100.00 Hz. The frequency amplitudes under the same exhaust pulsation frequency were 2.9 kPa, 3.3 kPa, 3.7 kPa, and 4.2 kPa when particulate depositions in the DPF were 0 g, 20 g, 40 g, and 60 g, respectively.

Note that the instantaneous exhaust pressure under the constant engine condition is a stationary signal, so Figure 6 gives the calculation results based on the Fourier spectrum. In real engine conditions, the instantaneous exhaust pressure is an unsteady signal. In this paper, we assumed it was quasi-steady state (because the exhaust pulsation frequency is low and constant under the certain engine condition).

To get the sensitivity of the frequency amplitude under the exhaust pulsation frequency versus particulate depositions in the DPF, Figure 7 gives the effects of particulate depositions in the DPF on the frequency amplitude under exhaust pulsation frequency under different engine conditions.

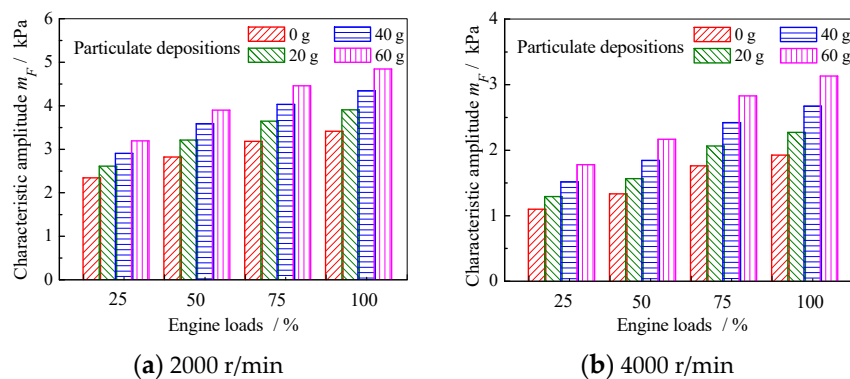

Figure 7. Effects of particulate depositions in the DPF on the frequency amplitude under exhaust pulsation frequency.

As shown in Figure 7, when the engine speed was 2000 r/min or 4000 r/min, under different engine loads, the frequency amplitude under exhaust pulsation frequency increased obviously with the increase in particulate depositions in the DPF. In addition, the frequency amplitude under exhaust pulsation frequency increased obviously with the increase in diesel engine loads, regardless of the engine speed. Also, compared Figure 7a with Figure 7b, under the same engine load, the frequency amplitude under exhaust pulsation frequency when the engine speed was 4000 r/min was smaller than when the engine speed was 2000 r/min.

Based on the above analysis, we can determine that the frequency amplitude under exhaust pulsation frequency may be used as characteristic parameter to diagnose the blockage extent of DPFs. The frequency amplitude under exhaust pulsation frequency is defined as characteristic frequency amplitude in this paper.

5. Comparison between Characteristic Frequency Amplitude and Mean Exhaust Pressure

According to the analysis of Sections 3 and 4, both mean exhaust pressure and characteristic frequency amplitude of instantaneous exhaust pressure may be used as characteristic parameters

to diagnose the blockage extent of DPFs. However, which one is more sensitive to the variation in particulate depositions in DPFs (more qualified to monitor the blockage extents of DPF) requires further comparative research.

Next, this paper will study the sensitivity of mean exhaust pressure change rate and characteristic frequency amplitude change rate under different particulate depositions in DPF. The change rate of mean exhaust pressure is defined by formula (1), while the change rate of characteristic frequency amplitude is defined by formula (2):

$$\theta_{P_1} = \frac{P_{1x} - P_{10}}{P_{10}}, \quad (1)$$

$$\theta_{m_F} = \frac{m_{Fx} - m_{F0}}{m_{F0}}, \quad (2)$$

where P_{1x} represents the mean exhaust pressure when particulate depositions exist in the DPF, P_{10} represents the mean exhaust pressure when particulate deposition is 0 g in the DPF, m_{Fx} represents the characteristic frequency amplitude when particulate depositions exist in the DPF, m_{F0} represents the characteristic frequency amplitude when particulate deposition is 0 g in the DPF.

Figures 8 and 9 provide a comparison of the mean exhaust pressure change rate with characteristic frequency amplitude change rate under different particulate depositions at 2000 r/min and 4000 r/min.

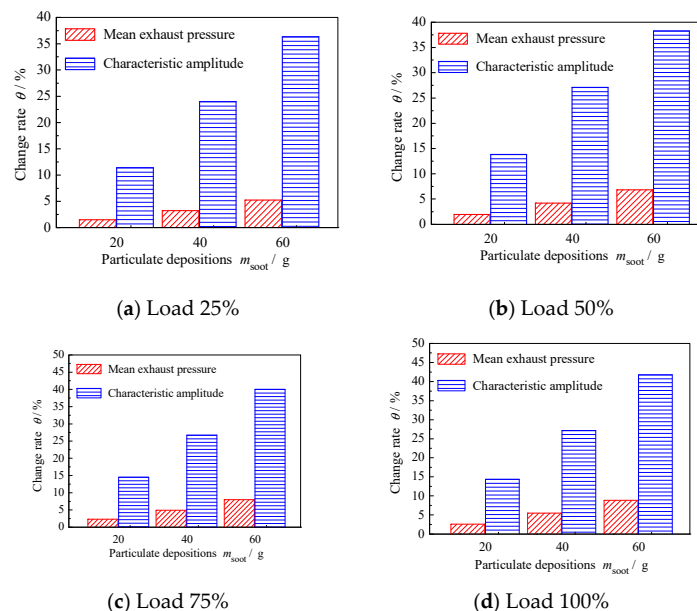

Figure 8. Comparison of mean exhaust pressure change rate with characteristic frequency amplitude change rate under different particulate depositions at 2000 r/min.

As shown in Figures 8 and 9, despite engine conditions and particulate depositions in DPF, the change rate of the characteristic frequency amplitude was always greater than the change rate of mean exhaust pressure. Take Figure 9, for example, when particulate depositions in DPF increased from 0 g to 20 g, the change rates of mean exhaust pressure under different engine loads were less than 5%, while the change rates of characteristic frequency amplitude were greater than 15%; when particulate depositions in the DPF increased from 0 g to 40 g, the change rates of mean exhaust pressure under different engine loads were less than 10%, while the change rates of characteristic frequency amplitude were greater than 25%; when particulate depositions in the DPF increased from 0 g to 60 g, the change rates of mean exhaust pressure under different engine loads were less than 15%, while the change rates of characteristic frequency amplitude were greater than 35%.

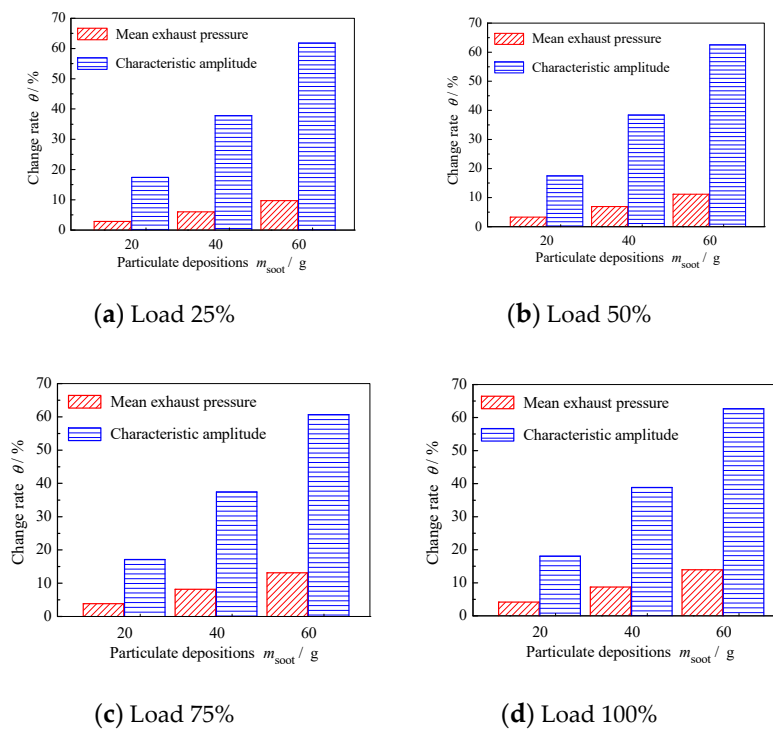

Figure 9. Comparison of mean exhaust pressure change rate with characteristic frequency amplitude change rate under different particulate depositions at 4000 r/min.

The major reason for this is that mean exhaust pressure represents the average value of pressure in a relatively long period, so the value is relatively great and the effect of particulate depositions in the DPF on mean exhaust pressure is small, while characteristic frequency amplitude represents the frequency amplitude component under exhaust pulsation frequency, so the value is relatively small and the effect of particulate depositions in the DPF on characteristic frequency amplitude is great. Therefore, characteristic frequency amplitude is more sensitive than mean exhaust pressure to the variation in particulate depositions in the DPF.

A comparison of Figures 8 and 9 shows that under the same engine speed, the difference in the change rate of characteristic frequency amplitude was not obvious with different engine loads. Also take Figure 9, for example, when particulate depositions in the DPF increased from 0 g to 40 g, the change rates of the characteristic frequency amplitude were 37.8%, 38.4%, 37.4%, and 38.8% with different engine loads (25%, 50%, 75%, 100%, respectively).

In addition, it was also found that when the diesel engine speed was 2000 r/min, the change rate of the characteristic frequency amplitude was less than the value when engine speed was 4000 r/min under the same conditions. When particulate depositions in the DPF increased from 0 g to 60 g, the change rate of the characteristic frequency amplitude was about 40% at 2000 r/min, while the change rate of the characteristic frequency amplitude was about 60% at 4000 r/min.

Therefore, in terms of sensitivity, the characteristic frequency amplitude of instantaneous exhaust pressure is more suitable as a characteristic parameter to monitor DPF blockage than mean exhaust pressure.

Finally, this method is correct under constant engine condition and under the assumption that the instantaneous exhaust pressures in real engine conditions are a quasi-steady state. For more accuracy in further study, wavelet transform and Hilbert Huang Transform (HHT) will be the better research methods.

6. Conclusions

In this paper, a simulation method was used to study the fault diagnosis of blocking DPFs by using spectral analysis on instantaneous exhaust pressure. From the results of this investigation, some conclusions can be drawn:

(1) A simulation model of an R425DOHC diesel engine with wall-flow ceramic DPF was established, and then the correctness of the model was verified with experimental data;

(2) Under different engine conditions, mean exhaust pressure increases obviously with the increase in particulate depositions in DPF. Mean exhaust pressure increases with the increase in diesel engine loads, regardless of the engine speed. Under the same engine load, the mean exhaust pressure of pre-DPF when the engine speed is 4000 r/min is greater than that when the engine speed is 2000 r/min. Monitoring the mean exhaust pressure pre-DPF is a way to understand the situation of particulate depositions in the DPF so that we can diagnose the blockage extents of DPF;

(3) Under different engine conditions, instantaneous exhaust pressure increases with the increase in particulate depositions in the DPF, and the peak and trough values of instantaneous exhaust pressure increase obviously in one exhaust cycle. However, it is difficult to diagnose the blockage extent of a DPF by monitoring instantaneous exhaust pressure in the time domain. Characteristic frequency amplitude decreases gradually as the increase in engine speed, but increases with an increase in engine loads, and the increasing extent of characteristic frequency amplitude decreases gradually with an increase in particulate depositions in the DPF. Characteristic frequency amplitude may be used as a characteristic parameter to diagnose the blockage extent of DPFs;

(4) Despite engine conditions and particulate depositions in DPFs, the change rate of characteristic frequency amplitude is always greater than the change rate of mean exhaust pressure. Under the same engine speed, the difference in the change rate of characteristic frequency amplitude is not obvious with different engine loads. The change rate of characteristic frequency amplitude when engine speed is 2000 r/min is less than the value when engine speed is 4000 r/min under the same conditions;

(5) In terms of sensitivity, the characteristic frequency amplitude of instantaneous exhaust pressure is more suitable as a characteristic parameter to monitor DPF blockage than mean exhaust pressure.

Author Contributions: S.-x.L. and M.L. write the article, collect and analyze data together.

Funding: This research was funded by the National Natural Science Foundation of China, grant number 51606006, 51776016; Beijing Natural Science Foundation, grant number 3182030; and the National Engineering Laboratory for Mobile Source Emission Control Technology, grant number NELMS2017A10.

Acknowledgments: Thanks Zhi Ning from Beijing Jiaotong University for supporting critical revision of this article.

Conflicts of Interest: The authors declare no conflict of interest.

References

1. Johnson, T.V. Diesel Emission Control in Review. *SAE Int. J. Fuels Lubr.* **2009**, *1*, 68–81. [[CrossRef](#)]
2. Baek, K.; Choi, H.; Bae, G.; Woo, M. A Study on Regeneration Strategies of Cordierite-DPF Applied to a Diesel Vehicle. In *SAE Paper*; The Automotive Research Association of India: Pune, India, 2011.
3. Bensaïd, S.; Marchisio, D.L.; Fino, D.; Saracco, G.; Specchia, V. Modelling of diesel particulate filtration in wall-flow traps. *Chem. Eng. J.* **2009**, *154*, 211–218. [[CrossRef](#)]
4. Maricq, M.M. Chemical characterization of particulate emissions from diesel engines: A review. *J. Aerosol Sci.* **2007**, *38*, 1079–1118. [[CrossRef](#)]
5. Surve, P.R. Diesel Particulate Filter Diagnostics Using Correlation and Spectral Analysis. ECE Master's Thesis, Purdue University, West Lafayette, IN, USA, 2008.
6. Shim, B.J.; Park, K.S.; Koo, J.M.; Nguyen, M.S.; Jin, S.H. Estimation of soot oxidation rate in DPF under carbon and non-carbon based particulate matter accumulated condition. *Int. J. Automot. Technol.* **2013**, *14*, 207–212. [[CrossRef](#)]
7. Shah, C.D. Particulate matter load estimation in diesel particulate filters. Master's Thesis, Purdue University, West Lafayette, IN, USA, 2008.

8. Liu, Z.G.; Berg, D.R.; Swor, T.A.; Schauer, J.J. Comparative analysis on the effects of diesel particulate filter and selective catalytic reduction systems on a wide spectrum of chemical species emissions. *Environ. Sci. Technol.* **2008**, *42*, 6080–6085. [[CrossRef](#)] [[PubMed](#)]
9. Chen, L.; Ma, Y.; Guo, Y.; Zhang, C.; Liang, Z.; Zhang, X. Quantifying the effects of operational parameters on the counting efficiency of a condensation particle counter using response surface Design of Experiments (DoE). *J. Aerosol Sci.* **2017**, *106*, 11–23. [[CrossRef](#)]
10. Bensaïd, S.; Marchisio, D.L.; Russo, N.; Fino, D. Experimental investigation of soot deposition in diesel particulate filters. *Catal. Today* **2009**, *147*, S295–S300. [[CrossRef](#)]
11. Van Nieuwstadt, M.; Brahma, A. Uncertainty analysis of model based diesel particulate filter diagnostics. *SAE Int. J. Commer. Veh.* **2009**, *1*, 356–362. [[CrossRef](#)]
12. Bensaïd, S.; Marchisio, D.L.; Fino, D. Numerical simulation of soot filtration and combustion within diesel particulate filters. *Chem. Eng. Sci.* **2010**, *65*, 357–363. [[CrossRef](#)]
13. Ochs, T.; Schittenhelm, H.; Genssle, A.; Kamp, B. Particulate matter sensor for on board diagnostics (OBD) of diesel particulate filters (DPF). *SAE Int. J. Fuels Lubr.* **2010**, *3*, 61–69. [[CrossRef](#)]
14. Ntziachristos, L.; Fragkiadoulakis, P.; Samaras, Z.; Janka, K.; Tikkanen, J. Exhaust particle sensor for OBD application. In *SAE Technical Paper*; SAE International: Troy, MI, USA, 2011.
15. Cloudt, R. Diagnostics development for cost-effective temperature sensor based particulate matter OBD method. *SAE Int. J. Passeng. Cars-Electron. Electr. Syst.* **2014**, *7*, 573–582. [[CrossRef](#)]
16. Kumar, S.V.; Heck, R.M. A new approach to OBD monitoring of catalyst performance using dual oxygen sensors. *SAE Trans.* **2000**, *109*, 586–595.
17. Gupta, A.; Franchek, M.; Grigoriadis, K.; Smith, D.J. Model based failure detection of Diesel Particulate Filter. In *Proceedings of the 2011 American Control Conference*, San Francisco, CA, USA, 29 June–1 July 2011; pp. 1567–1572.



© 2019 by the authors. Licensee MDPI, Basel, Switzerland. This article is an open access article distributed under the terms and conditions of the Creative Commons Attribution (CC BY) license (<http://creativecommons.org/licenses/by/4.0/>).